

# **Proceedings IEA Workshop Legionella**

Delft, The Netherlands, 4/5 October 2001

Compiled by Jos Warmerdam and Renée Caris (Ecofys, Utrecht)



## Summary

### Goal of the workshop

The goal of the workshop is to investigate the risk of bacterial growth in solar water heaters and the risk of Legionnaire's disease for future growth of the solar water heaters market.

The workshop was divided in three parts:

- overview per country;
- research done;
- discussion how to proceed.

### Overview per country

*EU:* EU-directives are very general, 'water should be safe'. In 1998 publishing of new Drinking Water Directive (98/83/EG). In EN 806-2 is stated 'The hot water temperature in the pipe work shall not drop below 50 °C'.

*Netherlands:* Since outbreak of Legionella on flora in Bovenkarspel (1999) with 32 dead, Legionella is a hot topic in the Netherlands. This resulted in Temporary Decree for Legionella Prevention in Tap Water, in which is stated that by 15 October 2001 all public or collective drinking water systems should have had a risk analysis. If there is a risk, a control plan must be implemented. Temperature at tap should be 60°C at least. As soon as Legionella is detected, action must be undertaken to get rid of it.

*Denmark:* There is no specific legislation, normal regulations for hot water production are valid. All measures are recommendations. 50°C at tap is enough. Proposed reaction limits: < 1.000 cfu/l no action, >100.000 corrective measures should be taken.

*France:* There are draft new regulations with three main requirements: 1. Temperature of domestic hot water should never exceed 50°C at drawing point (so mixing valve is necessary); 2. Temperature of collective distribution network must be higher than 50°C; 3. If water in storage for more than 24 hours it should be heated up to > 60°C when volume is > 400 litre or when volume in pipe to most distant drain up > 3 litre.

*Germany:* For several years now the codes of practice W551 (new buildings) and W552 (old buildings) are valid. These codes of practice intend to reduce Legionella growth in drinking water heating systems and conduits. A distinction is made between small and large systems. Small systems are considered to have a very low risk so they need no special attention. Small systems are installations in one or two family houses, or installations with volume < 400 litre and a volume < 3 litre in pipe between heater outlet and draw off point. Large systems should be designed so that they can be heated up to 60 °C once a day.

*Sweden:* There is no specific legislation, normal regulations for hot water production are valid Installations for hot water shall be designed so that the temperature at the hot water tap is not less than 50°C and the temperature of circulating hot water shall not fall below 50°C. A recommendation is that the temperature of hot water in calorifiers or storage tanks should be not less than 60°C. 95% of thermal Solar panels systems are both for hot water and for water heating the building. Low risk of growth of

Legionella because it is the heated water which is accumulated. There has not been any known case of Legionellosis in Thermal Solar panels systems. Boverket had produced a brochure on Legionella for house owners (in English).

*Belgium:* Outbreak in November 1999 at whirlpool on exhibition. No specific regulation yet, but there is a proposal for regulations in region of Flanders concerning buildings open for the public. Requirements are cold water < 20 °C and hot water > 60 °C. All systems must have risk analysis, a Legionella managing plan and a log-book.

*United Kingdom:* Approved code of practice and guidance in place since 1991, revised in 2001. The Health and Safety at work etc act of 1974 gives health & safety inspectors the possibility to enter and inspect all sites, to issue enforcement's notices and eventually to prosecute. Temperature in storage > 60 °C, cold water < 20 °C. Separate action levels: < 100 cfu/litre is under control, > 1.000 cfu/litre means immediate action. There are thousands of companies that do inspections. For individual houses there are nearly no restrictions.

### **Research done**

General characteristics of the Legionella bacteria were presented.

More specific the Dutch ISSO publication 55.1 that describes the risk analysis was discussed. Part of it is a risk qualification of every part of the system. Total outcome should be neutral at least. It contains also lists of control measures and registration lists for logbook.

In Denmark two studies on domestic water heaters have been done. The first study was on the growth of bacteria in 12 solar prepared tanks and 12 traditional tanks. There were hardly any differences in bacterial counts. The bacterial counts were low compared to other investigations on larger systems in flats. In the second, following study, hot water samples were taken out of real domestic hot water systems and checked for Legionella. Five out of 24 boilers contained Legionella: none in the solar prepared tanks, one in traditional tanks and 4 out of 8 in the solar tanks. The level was considered low, and there was no time left to do thorough analysis of the systems conditions. The temperature level in the systems was rather low (40 – 50°C), which could stimulate the bacterial growth.

In France research was done with Legionella injected in a large hot water system (3 vessels of 1500 litres each). The Legionella was attacked with different control strategies. Main conclusions are that Legionella reduces 2 log for a heating period of 8 hours at 65 °C, after 2 days there was no Legionella detected at output of systems (in any scenario), temperature of 70 °C is not sufficient to eradicate Legionella in all the system (it is still present in piping without circulation).

In Belgium a research project is running for 2000-2002 aiming at evaluation - in situ - of anti Legionella treatments for sanitary hot water (physical and chemical).

### **General conclusions**

- Difference between large and small systems: is there a real problem in single family dwellings? There are no statistics, but Legionella has been found in some cases.
- There is a shift to higher risk factors by new building methods and regulations.

- What is large? Depends on volume/residence time/complexity/consumption rate/temperature.
- There is very little exact information, but risk analysis seems to be effective.
- All countries have specific situations, but the measures are quite similar.
- What is the right action level? There is not much science on this, only empirical data. Costs of sampling are a problem (in UK costs are relatively low because of high degree of automation).
- Engineers and biologists should work together.

### **Discussion how to proceed**

The discussion was in general about the following items:

- What should be done (regulations/R&D)?
- What is already known?
- What can be done internationally?
- How to fit in solar water heaters?
- Who would finance the work?
- Further actions?

### *Possible research topics*

- 1) How to reduce scale formation, effect on Legionella? In the UK and Denmark some work has been done on this, but not in relation to Legionella. There should come a study on what information is available and with background information.
- 2) Corrosion: types and their effect? Similar to scale formation.
- 3) What's going on in real situations (small systems)? In Denmark measurements have been performed, in The Netherlands this will be done next year. Results should be compared internationally. Effect of change 50 to 60 °C empirical relations on SWH.
- 4) What is the optimal design of storage (heat exchangers), and of a whole system (solar)? May be topic for IEA task 26 (solar combi systems). In The Netherlands research is scheduled for inherent Legionella save solar water heater.
- 5) What are the correlation materials, biofilm and Legionella growth? In The Netherlands some research had been done recently by KIWA.
- 6) How to commission water systems in buildings? This is a subject that should be treated nationally.
- 7) What are alternatives for high disinfection temperatures? There are a lot of developments going on concerning this subject. In Europe there should come a standard way of evaluating new methods. There is much uncertainty on effectiveness of the different disinfection methods.
- 8) Real operational conditions, effectiveness of different (control) measures (empirical, small/large systems).
- 9) Practical design issues (how high is risk at cold site of mixing valve? How long can a dead end be, so when should action be undertaken?). Necessary to understand infected situations. Monitor new installations to control measures taken.

### *Further actions*

It is not directly clear where funding can be found to do more research. All persons will check their channels.

There is a need for a broader platform a Legionella in hot water systems.

Preliminary search on scaling (Reginald Brown)

Probably there is funding in UK for research on disinfection (Reginald Brown).

Is there an English report/summary of the research done by KIWA on the biofilm potential of materials (Hans van Wolferen)?

Lex Bosselaar will propose the item on solar tanks as work item to the IEA Solar Heating and Cooling exco.

### **Attendants**

|                 |   |
|-----------------|---|
| Belgium:        | Karel de Cuyper (BBRI)  |
| Denmark:        | Klaus Ellehauge (DTI), Lene Karen Bagh (Rovesta)  |
| France:         | Bruno Ziegler (EDF/DER), Frederic Bonnefoi (Costic)   |
| Germany:        | Dieter Waider (DVGW, only Thursday morning), Karl Leidig (Solar-Leidig)   |
| Netherlands:    | Jeanette Hofman (NEN, only Thursday morning), Hans van Wolferen (TNO), Lex Bosselaar (Novem, IEA SH&C), Jos Warmerdam (Ecofys), Daniel Naron (TNO, only Friday morning) |
| Sweden:         | Bertil Jönsson (Boverket)   |
| United Kingdom: | Reginald Brown (BSRIA)  |

### **Relevant organisations**

SAVE / Craft

EU Health related programmes

EWGLI (European Working Group for Legionella Infections: [www.ewgli.org](http://www.ewgli.org))

Standardisation organisations:

- CEN: TC 109, TC 164 (wg 3), TC 312 (Solar water systems);
- CENELEC TC 59 (electrical systems).

EUREAU (organisation of European water companies)

CPD mandate 136 (materials in contact with drinking water)

ASTIG / ESIF (solar companies)

ASHRAE / REHVA (engineers organisations, resp. United States/Europe)

CIB W62 (water supply and drainage)

IEA SH&C (International Energy Agency, Solar Heating & Cooling programme)

Hot water suppliers

WHO (World Health Organisation)

## Contents

|  |    |
|--|----|
| Summary .....  | 2  |
| Contents .....   | 6  |
| Programme .....  | 7  |
| Participants .....   | 8  |
| 1 Legionella in the Netherlands .....  | 9  |
| 2 Legionella and hot water systems in Denmark .....  | 12 |
| 3 Present regulation and new regulation project on Legionella<br>prevention in France..... | 16 |
| 4 DVGW Code of Practice W 551 (Germany) .....  | 18 |
| 5 Regulatory aspects: Sweden .....   | 21 |
| 6 Legionella in Belgium.....   | 23 |
| 7 Control of Legionellosis in the UK .....   | 25 |
| 8 Legionella in Hot Tap Water Production.....  | 28 |
| 9a Bacterial growth in solar heating prepared and traditional tanks .....                  | 48 |
| 9b Bacterial growth in solar heating prepared, traditional and solar<br>tanks .....        | 54 |
| 10 Concentration of Legionella in hot water electrical storage systems                     | 56 |
| 11 Risk of Legionnaires' disease in Solar Water Heaters - Status report                    | 63 |
| 12 In situ survey of Legionella in Belgium.....  | 67 |
| 13 Legionella research topics.....   | 69 |
| 14. Microbiological safety of Solar Domestic Hot Water Systems .....                       | 71 |

## Programme

Location: Hotel Nieuw Minerva ('Wijnzaal'), Leiden, The Netherlands.

Thursday October 4, 2001

09.30-10.00 Registration, coffee/tea

Morning session: regulatory aspects, state of the art in different countries

10.00-10.10 Opening by Lex Bosselaar

10.10-10.30 Netherlands, Jeanette Hofman (NEN)

10.30-10.50 Denmark, Klaus Ellehauge (DTI), Lene Karen Bagh (Rovesta)

10.50-11.20 France, Frederic Bonnefoi (Costic)

11.20-11.30 *Short break*

11.30-11.50 Germany, Dieter Waider (DVGW)

11.50-12.10 Sweden, Bertil Jönsson (Boverket)

12.10-12.30 Belgium, Karel de Cuyper (BBRI)

12.30-12.50 United Kingdom, Reginald Brown (BSRIA)

12.50-13.00 General discussion

13.00-14.00 Lunch

Afternoon session: technical aspects

14.00-14.30 Hans van Wolferen: *1. Introductions to Legionella. 2. Research in the Netherlands.*

14.30-15.00 Lene Karen Bagh: *Investigation of Danish hot water tanks and solar hot water storages for bacteria growth and especially for growth of Legionella.*

15.00-15.10 *Short break*

15.10-15.40 Bruno Ziegler: *Concentration of Legionella in hot water electrical storage systems.*

15.40-16.10 Dr. Karl Leidig: *Experiences in Germany.*

16.10-16.40 K. De Cuyper: *In-situ survey of anti Legionella treatments.*

16.40-17.00 General discussion

19.00 Dinner at koetshuis De Burcht, Leiden.

Friday October 5

08.30-09.00 Coffee/tea

Morning session:

09.00 Discussion on following subjects:  
Is Legionella an item in the different countries?  
What activities are needed?  
Is international co-operation needed?

12.30 Closing

## Participants

### *Belgium*

Karel de Cuyper      BBRI

### *Denmark*

Klaus Ellehauge      DTI  
Lene Karen Bagh      Rovesta

### *France*

Bruno Ziegler      EDF/DER  
Frederic Bonnefoi      Costic

### *Germany*

Dieter Waider      DVGW (only Thursday morning)  
Karl Leidig      Solar-Leidig

### *Netherlands*

Daniel Naron      TNO (only Friday morning)  
Hans van Wolferen      TNO  
Jeanette Hofman      NEN (only Thursday morning)  
Jos Warmerdam      Ecofys  
Lex Bosselaar      Novem

### *Sweden*

Bertil Jönsson      Boverket

### *United Kingdom*

Reginald Brown      BSRIA



# 1 Legionella in the Netherlands

**Jeannette Hofman**  
**NEN, Netherlands Normalization Institute**  
**P.O.Box 5059, NL-2600 GB DELFT, The Netherlands**  
**Tel: +31 (0)15 26 90 338**  
**Fax: +31 (0)15 26 90 688**  
**E-mail: [Jeannette.Hofman@nen.nl](mailto:Jeannette.Hofman@nen.nl) Website: [www.nen.nl](http://www.nen.nl)**

## General

Legionella is the nowadays common shortcut for 'Legionella pneumophila' a bacterium that was discovered in 1976 in the USA by dr. J. McDade [1]. Reason for research in this field was a series of mysterious deaths after a conference of veterans in Philadelphia.

Dr. McDade discovered that they were caused by the bacterium and the accompanying disease was called 'legionnaire's disease'.

Shortly after the discovery of the bacterium it was found that the disease could mainly be caught by inhaling a large amount of Legionella. It was also discovered that the bacterium grows best in relatively hot water. Therefore it was concluded that water taps, and mainly hot water taps, form the largest risks for people to get the legionnaire's disease. Ever since, the bacterium keeps experts, politics and press busy.

## Dutch situation

### *Drinking water*

In The Netherlands legionnaire's disease was first discovered in 1977 [2]. In the following years a lot of research on the disease was carried out worldwide. In The Netherlands this led in 1986 to an official advice for hospitals of the National Health Council [3] to realise a water temperature of minimum 60°C at the outlet, and give hospitals an obligation to report any case of the legionnaire's disease.

In the years after that no regulations other than the general requirement that water supplied has to be safe for men's health have been published. Even the European Council has not given any special rule on Legionella in the new Drinking Water Directive that was published in 1998 [4]. In article 4, general requirements, it states under paragraph 1 subsection a that water intended for human consumption is clean when it contains: 'no micro-organisms, parasites or other substances in amounts or concentrations that can be dangerous for public health'.

In The Netherlands the situation changed in 1999 when about 30 people having attended a flower exhibition in Bovenkarspel lost their lives because of Legionella.

Up to that moment one thought that the rules and regulations in The Netherlands were more than sufficiently safe to prevent the public from such an accident. As a consequence of the accident the Dutch government promised to set up a large research program on Legionella and the 'Temporary Decree for Legionella Prevention

in Tap Water' was published by the Ministry of Housing, Spatial Planning and the Environment (VROM) based on the knowledge of that time [5]. The Decree states that owners of public or collective systems have to carry out a risk analysis for Legionella prevention and, if necessary, draft a control plan.

The technical aspects of the Temporary Decree are specified in the ISSO 55.1 publication 'Guide for Legionella Prevention in Tap Water' [6]. This guide specifies how a risk analysis should be carried out and how control plans can be set up.

As stated, the Temporary Decree for Legionella Prevention in Tap Water gives rules for public or collective drinking water systems. There is no special regulation for private housings. Momentarily, there are developments in The Netherlands, which should result in an advice for private housings in the draft of the revised NEN 1006, the Dutch standard 'General Requirements for Drinking Water Installations' [7].

Because regulations for Legionella prevention mostly lead to certain temperature requirements this standard is strongly under discussion at the moment. Higher temperature requirements can lead to difficulties for for instance producers of Solar Heating Equipment. There is no doubt that requirements in NEN 1006 will lead to a much less positive energy balance. It is even possible that the requirements can not be fulfilled because of technical limitations of the solar installations.

NEN 1006 is a document that is referred by the Dutch Drinking Water Act [8] and therefore part of this legislation. The latest revision of NEN 1006 is initiated by the national authorities because of the obligation of the implementation of the European Drinking Water Directive in the Netherlands. The Dutch Drinking Water Act has been changed according to this European Directive and accordingly so will NEN 1006. The European Standard that fits in this context is the draft NEN-EN 806-2 [9]. It gives the temperature requirements that should make the installations Legionella save but gives individual countries much space too: 'The hot water temperature in the pipework shall not drop below 50°C. National and local laws and regulations may require higher minimum temperature'.

In The Netherlands there are two different opinions at the moment. One states that temperatures have to be set as high as possible to be sure that Legionella is killed; the other states that the Netherlands should set requirements that are comparable to those in the rest of Europe in order to avoid trade barriers.

As European directives and standards are not specific with regards to temperature requirements it is very difficult for the Dutch authorities to find a compromise between the two opinions. Only detailed research that will set the temperature requirements on a scientific base will help to solve this problem.

Besides that, recent news from Legionella accidents in the Spanish town of Mucia [10] and from other countries show that this problem is not a Dutch one but is a worldwide problem which possibly should be solved on a worldwide scale.

**Process water, cooling towers and air conditioners**

Regulations with respect to process water, cooling towers and air conditioners are given in the Dutch Occupational Health and Safety Act [11]. Up to this moment the regulations also contain relatively general requirements with respect to public health.

Research has shown that the before mentioned installations can be risky with respect to a possible Legionella contamination. At the moment research is carried out which should elucidate whether detailed specifications have to be included into the Dutch Occupational Health and Safety Act.

**Literature**

[1] McDade, J., Speech during the 5<sup>th</sup> international Legionella Conference, 26-29 September 2000, Ulm (D).

[2] Meenhorst, P.L., Legionnaire's disease. Some clinical diagnostic and epidemiological aspects, PhD. thesis, Leiden, 1984.

[3] Dutch National Health Council, 1986, Advice for prevention of Legionellosis, Dutch National Health Council, The Hague, 1986.

[4] European Directive 98/83/EG 'Quality of Water meant for Human Consumption', 3 November 1998.

[5] Tijdelijke regeling Legionella preventie in leidingwater (Temporary Decree for Legionella Prevention in Tap Water) Ministry of Housing, Spatial Planning and the Environment (VROM) 13 October 2000.

[6] Isso 55.1 – Handleiding Legionella Preventie in Leidingwater (Guide for Legionella Prevention in Tap Water) ISSO, Rotterdam, The Netherlands, 2000.

[7] NEN 1006 (draft), General requirements for drinking water installations, NEN, Delft, 2001.

[8] Dutch Drinking Water Act, Ministry of Housing, Spatial Planning and the Environment (VROM), Staatsblad 2000, nr. 295V, The Hague, September 13<sup>th</sup>, 2000.

[9] NEN-EN 806-2, Specifications for installations inside buildings conveying water for human consumption, Part 2: Design. NEN, 1996.

[10] Edwin Winkels, Paniek na uitbraak Legionella, Algemeen Dagblad 10/7, 2001.

[11] Dutch Occupational Health and Safety Act, Dutch Ministry of Social Affairs, as published in 'Staatsblad 2000, nr. 595, The Hague, December 28<sup>th</sup>', 2000.

## 2 Legionella and hot water systems in Denmark

Lene Karen Bagh  
Rovesta  
Betonvej 12, DK-4000 ROSKILDE, Denmark  
Tel: +45 46 77 37 94  
Fax: +45 46 77 37 95  
E-mail: [lkb@rovesta.dk](mailto:lkb@rovesta.dk) Website: [www.rovesta.dk](http://www.rovesta.dk)

M.Sc. Klaus Ellehauge  
Danish Technological Institute  
Teknologiparken, DK-8000 ÅRHUS C, Denmark  
Tel: +45 7220 1370  
Fax: +45 7220 1019  
E-mail: [klaus.ellehauge@teknologisk.dk](mailto:klaus.ellehauge@teknologisk.dk) Website: [www.solenergi.dk/center/](http://www.solenergi.dk/center/)

*(powerpoint presentation)*

### Contents

Lene Karen Bagh:

- Historical aspects
- Problems related to hot water
- Danish regulations
- Public and political awareness
- Main partners involved

Klaus Ellehauge:

- Specific regulations concerning solar water heaters
- Main partners involved

### Historical aspects

In principle hot water should keep the limits for drinking water

Danish Environmental Protection Agency: Maximum admissible number of bacteria is 20 CFU/ml (HPC 37°C)

Development of new methods for monitoring HPC in hot water (Danish Standard) with focus on Thermophiles

Monitoring of Legionella in hot water installations

Legionella problems at hospitals and in bigger apartment buildings

Development of equipment for reducing the growth of Legionella

### Problems related to hot water

Health related problems

- Legionella
- HPC
- Skin Allergies

Technical problems

- Increased heat transfer resistance
- Corrosion

## Aesthetic problems

- Bad smell
- Muddy water
- Slime layers

**Main reasons for Legionella problems**

- Low operation temperatures
- Reduced water consumption
- Dead ends with stagnant water
- Long retention times
- Biofilm formation
- Corrosion
- Materials
- Calcium deposits and slime layers
- Maintenance of the installation
- Dimensions
- Regulation

**Danish Regulations**

- Ministry of Housing and Urban Affairs. Building Regulations for smaller houses (1995).
- Ministry of Housing and Urban Affairs. Building Regulations.
- Dansk Ingeniørforenings norm for vandinstallationer (DS 439).
- Miljøstyrelsen. Bekendtgørelse om vandkvalitet og tilsyn med vandforsyningssanlæg (2000).
- Sundhedsstyrelsen. Bekendtgørelse om lægers anmeldelse af smitsomme sygdomme (2000).
- Legionella i varmt brugsvand. Overvågning, udredning og forebyggelse af Legionærsygdom. Statens Serum Institut (2000).

**Drinking Water Directive (2000)**

Relations to EU Directive

Information to consumers

New limits and sampling strategies

No maximum admissible limits for Legionella

Hot water installations are not included.

**Drinking Water Directive (2000) Microbiological parameters**

| Parameter  | Enhed      | Værdi ved afgang fra vandværk | Værdi ved indgang til ejendom <sup>2)</sup> | Bemærkninger           |
|--|------------|-------------------------------|---|------------------------|
| Coliforme bakterier                                    | pr. 100 ml | i. d.                         | i. d.                                       |                        |
| Escherichia coli (E. coli)                             | pr. 100 ml | i. d.                         | i. d.                                       |                        |
| Kimtal ved 37 <sup>0</sup> C                           | pr. ml     | 10                            | 30  | Ny målemetode fra 2001 |
| Kimtal ved 22 <sup>0</sup> C                           | pr. ml     | 70                            | 250   | Ny målemetode fra 2001 |
| Enterokokker   | pr. 100 ml | i. d.                         | i. d.                                       |                        |
| Clostridium perfringens, herunder sporer <sup>3)</sup> | pr. 50 ml  | i. d.                         | i. d.                                       |                        |

### Proposed reaction limits in hot water installations

| Legionella (CFU/Liter) | Reaction limit for Legionella  |
|------------------------|--|
| 10 - < 1.000           | Low level of <b>Legionella</b> . However growth of Legionella within the system is possible.   |
| 1.000 - < 10.000       | Low and medium level of <b>Legionella</b> . The possibilities for improvements of the systems should be considered such as higher operation temperature , removal of dead ends etc . |
| 10.000 - < 100.000     | High level of <b>Legionella</b> . Improvements and/or disinfection should be considered. The condition is monitored.   |
| ≥ 100.000              | Very high level of Legionella. The system should be examined and corrective measures should be taken.  |

Modificeret efter Morris GK & Shelton BG. 1994. Statens Serum Institut. 2000.

### Public and political awareness

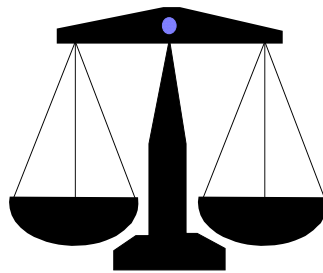

Low temperature

Energy saving

Promoting growth of Legionella

High temperature

Reducing growth of Legionella

Energy consuming

Growth of thermophiles

Corrosion

Scalding

### EU project

Design and Operation of Hot Water Systems and Application for On Site Electro-chemically Generated Chlorine Dioxide for Control of Legionella

CRAFT: Co-operative Research Action for Technology

April 2001, Guldager A/S, SME Co-ordinator.

### Main partners

- Statens Serum Institut - National Central Laboratory of the Danish Health System
- Danish Environmental Protection Agency
- The Danish Energy Agency
- The Danish Ministry of Housing and Urban affairs
- The Danish Committee on Human Health
- Rovesta Miljø I/S

- Danish Technological Institute
- Danish Technical University

### Regulations concerning solar water heaters

- No specific regulations for solar water heaters
- Has to fulfil normal regulations for hot water preparation  
I.e. Building Code: DS439 standard for water installation (1989)
  - The system shall be dimensioned so that the risk of bacteria growth is minimised
  - It should be possible to heat the water to 55-60 °C
  - The installation should be designed so that the temperature at the most distant hot water tap do not drop below 50°C
  - Heating surfaces shall be designed to minimise deposits
  - Heating surfaces shall be available for cleaning
  - Components used in water installation shall be approved (VA-approval)
  - Installation by certified installer.

For one family houses the system shall be able to deliver:

- Houses with bathtub: 125 litres at 40°C + tapping programme
- Houses with shower: Approx. 57 litres at 40-45 °C two times within 12 hours (with interval of 20 minutes).

### Conditions for subsidy for solar water heaters

Standard systems for single family houses: Approved components and system design (approved at Danish Solar Testing Laboratory).

Other systems: Specific approval at (approved at Danish Solar Testing Laboratory).

Installation by certified solar heating installer (certification at Danish Solar Testing Laboratory).

Typical solar hot water tank with 2 spiral heat exchangers

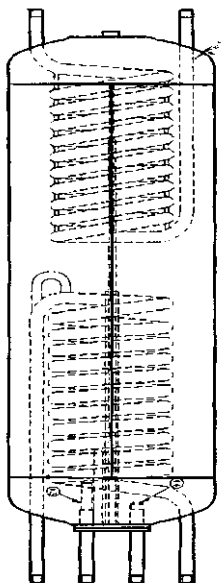

Typical solar hot water tank with mantle and spiral heat exchanger

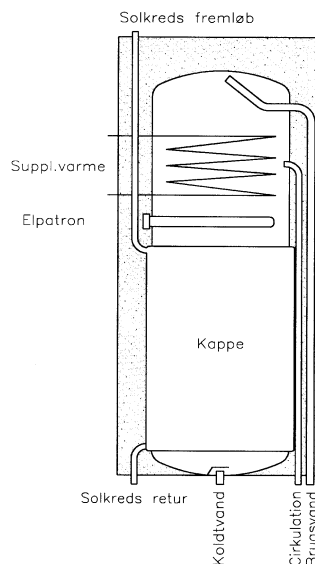

### 3 Present regulation and new regulation project on Legionella prevention in France

Frederic Bonnefoi  
COSTIC

Rue Lavoisier, Z.I. St. Christophe  
F-04000 DIGNE-LES-BAINS, France

Tel: +33 (0)4 92 31 19 30

Fax: +33 (0)4 92 32 45 71

E-mail: [F.Bonnefoi@costic.com](mailto:F.Bonnefoi@costic.com) Website: [www.costic.asso.fr](http://www.costic.asso.fr)

#### Introduction

1999: 440 declared cases (hospitals, hotels, campsites) ... including 59 deaths

2000: 582 declared cases including 77 deaths

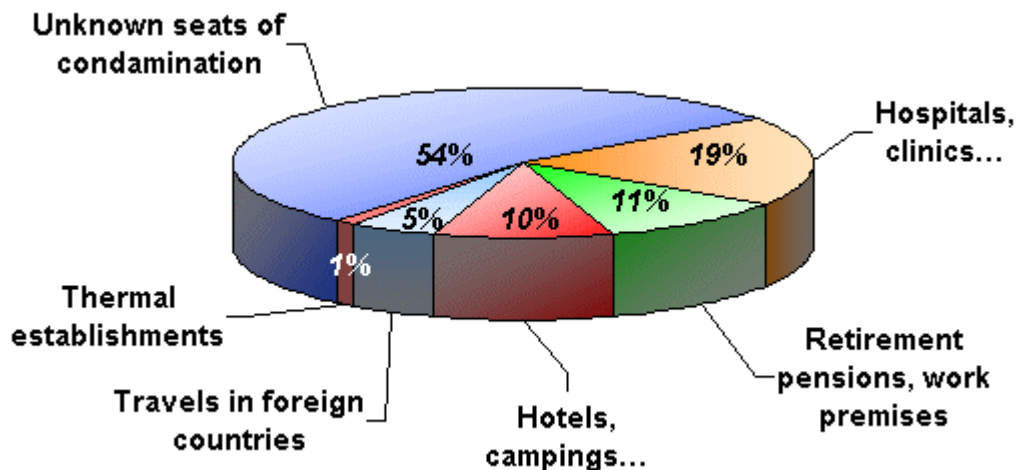

Source: Institut de Veille Sanitaire, 1999

For half of the cases, it appears impossible to determine the place of the contamination with certainty.

The establishments concerned with important risks of contamination are the buildings receiving people at the high infectious risks (hospital), the infrastructures of intermittent use (campsites, hotels, rooms of the sports... and the hydropathic establishments).

The number of legionellose cases noted in hospital is especially due to the fact that the people are weakened, therefore sensitive to the germs.



### Present regulations in France

- The legionellosis is a notifiable disease since 1988 (rules of WHO)
- « Decree 89-3 » defines the quality of drinking water to respect
- The techniques of fight and prevention are described by the circular n°97 - 311 of April 24, 1997 (Direction Générale de la Santé). It details also the technical investigations to achieve.
- The good practice rules of maintenance of the water networks (establishment of health) and the means of prevention (installations with risk ) are described by the circular n°98 -771 of December 31, 1998 (Direction Générale de la Santé).
- Arrêté du 23 Juin 1978 Article 36 - Installations of distribution of domestic hot water:
  1. “The temperature of domestic hot water should not exceed 60 °C at the point of drawing up. If necessary, for this purpose, an adjustment device must be at the user’s disposal.”
  2. “However, in the kitchens and the wash houses of the public establishments, water could be supplied at 90 °C in certain points being the subject of a particular indication.”

### New regulations project in France

A new project of decree, concerning the new installations settled within new or existing buildings, envisages to add to measures of the “Arrêté du 23 juin 1978 » the 3 following requirements:

1. “In the water rooms, the temperature of domestic hot water, should never exceed 50 °C at the points of drawing up.”
2. “In the collective distribution networks, with a controlled temperature, this one must be higher than 50 °C.”
3. “The domestic hot water, supplied by the devices of water tank production and which remains in the tank during more than 24 hours, must answer, for the period of exploitation of the aforesaid devices to, one of the following requirements:
  - to be at a temperature distribution higher than 60 °C at the exit of the device;
  - to raise the temperature higher than 60 °C during 24 hours before its use.

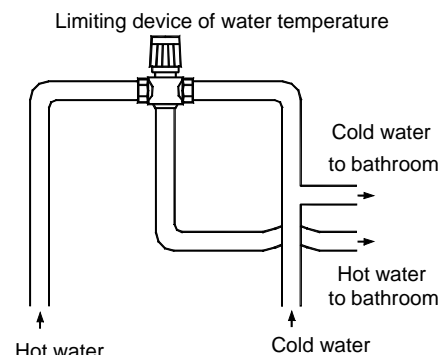

Those requirements applies in one of the two following cases:

- total volume out of domestic hot water of the device of production to accumulation is higher than 400 litres;
- volume out of water contained between the exit of the device of production of domestic hot water and the point of the most distant drawing up is higher than 3 litres.”

## 4 DVGW Code of Practice W 551 (Germany)

**Dieter Waider**  
**DVGW Hauptgeschäftsführung**  
Josef Wirmer Strasse 1-3, G-53123 BONN, Germany  
Tel: +49 (0)228 918 8854  
Fax: +49 (0)228 918 8994  
E-mail: [waider@divgw.de](mailto:waider@divgw.de) Website: [www.divgw.de](http://www.divgw.de)

*(powerpoint presentation)*

### **DVGW Code of Practice W 551**

Drinking water heating systems and conduits;  
Technical measures to decrease Legionella growth.

The application of this code of practice is intended to reduce Legionella growth in drinking water heating systems and conduits.

This code of practice complies with the recommendations of the Federal Office for Public Health towards a reduction of the infection risk with Legionella. (Bundesgesundheitsbl 30 Nr, July 7th 1987)

### **W 551 for new installations**

This code of practice applies to new installations (planning, construction and operation) of drinking water heating systems and conduits. A distinction is made between:

- small systems, for instance one and two family houses with reduced requirements due to low risk (possible operating temperature < 60 ° C);
- large systems, for instance residential buildings, old-age homes, hospitals, hotels, sporting and industrial installations.

### **Requirements for drinking water heaters**

Local circulating drinking water heaters ( with a volume of > 3l) can be used without taking any further measures for conduit lengths with water volumes of > 3 l.

Each storage drinking water heater shall have cleaning and maintenance openings of sufficient size, e.g. configuration of a handsize hole ( see DIN 4753, part 1).

The cold water inlet shall be designed in such a way that a large mixing zone is avoided during the draw off process.

### **Small systems**

Small systems are storage drinking water heaters and central circulating drinking water heaters in:

- one family houses;
  - two family houses;
  - installations with drinking water heaters with a volume of < 400 l and a volume of < 3 l in each pipe between the drinking water heater outlet and the draw off point.
- The circulating line is not taken into consideration in this case.

**Large systems**

Large systems are: all other installations which do not fall under the definition for small systems.

In case of storage drinking water heaters with a volume of > 400 l it must be ensured by design and by other measures ( e.g. circulation, in case of several cells with regular heating up of all cells) that the water is heated up in the whole system in a homogeneous way.

Drinking water systems shall be designed so that the total water volume of the preheating stages can be heated up to 60 ° C once a day.

During the intended operation it shall be possible to maintain a temperature of 60 °C<sup>1)</sup> at the hot water outlet of the drinking water heater.

<sup>1)</sup> Note: taking into account the switching difference of the regulator, the temperature shall never fall below 55 ° C.

**Circulation systems and self-regulating parallel heating systems**

In large systems circulation systems or parallel heating systems shall be installed.

Circulation lines and pumps or self-regulating parallel heating systems shall be dimensioned so that the hot water temperature in the circulating hot water system does not fall by more than 5 K below the outlet temperature of the drinking water heater.

In floor pipes and individual supply pipes with a water volume of > 3 l additional circulation lines or self-regulating parallel heating systems shall be mounted.

For individual supply pipes with a water volume > 3 l circulation lines or self-regulating parallel heating systems shall be mounted.

Individual supply pipes or self-regulating parallel heating systems shall be mounted in such a way to reach the point immediately upstream of the inline mixing valve.

**Operation**

Storage drinking water heaters and central circulating drinking water heaters.

For small systems it is recommended to set the temperature of the regulator at the drinking water heater to 60 ° C. Operating temperatures < 60 ° C are possible due to low risk. For large systems a temperature of 60 ° C<sup>1)</sup> shall be maintained at the water outlet of the drinking water heater. The total drinking water volume of the preheating stages shall be heated up to 60 ° C<sup>1)</sup> at least once a day.

<sup>1)</sup> Note: taking into account the switching difference of the regulator, the temperature shall never fall below 55 ° C.

**Circulation systems and self-regulating parallel heating systems**

Circulation systems and self-regulating parallel heating systems shall be operated in such a way that the water temperature in the system never falls by more than 5 K below the outlet temperature of the drinking water heater.

Timers for circulation pumps and self-regulating parallel heating systems shall be set in such a way that circulation is not interrupted by more than 8 hours a day.

**Notes to preheating stages**

- Solar water heaters are to be regarded as preheating stages;
- For small systems with solar water heaters, W 551 imposes no requirements at the preheating stage;
- Meanwhile there are many solutions for large systems.

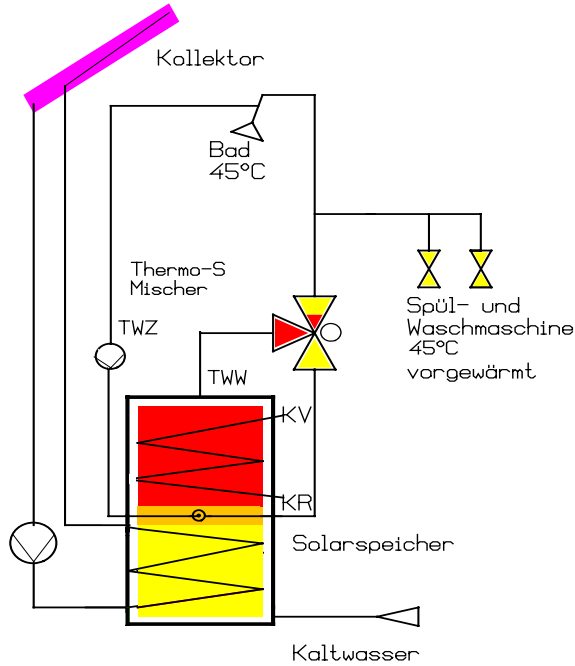

**SOLAR DIAMANT**  
*Die Sonne im Haus*

**Bivalente Speicher**

**Buderus**  
**HEIZTECHNIK**

Magnesiumanode  
Wärmetauscher Nachheizung  
Wärmetauscher Solar

**Bivalenter Speicher**  
Logalux SM300, SM400 und SM500

Magnesiumanode  
Wärmetauscher Nachheizung  
Wärmeleitrohr  
Wärmetauscher Solar

**Thermosiphonspeicher**  
Logalux SL300-1 (monovalent) oder  
Logalux SL300-2, SL400-2 und SL500-2 (bivalent)

Tinius/Wenisch  
©Buderus Heiztechnik GmbH. Alle Rechte vorbehalten.

Folie Nr.82.

## 5 Regulatory aspects: Sweden

**Bertil Jönsson**  
**National Board of Housing, Building and Planning**  
**P.O.Box 534**  
**S-371 23 KARLSKRONA, Sweden**  
**Tel: +46 455 35 32 67**  
**Fax: + 46 455 35 32 21**  
**E-mail: [bertil.jonsson@boverket.se](mailto:bertil.jonsson@boverket.se) Website: [www.boverket.se](http://www.boverket.se)**

### **Solar heated systems**

Sweden has not any special national building regulations for Solar heated systems. Instead our regulations consist of performance based requirements. In the field of water supply in buildings it is the mandatory requirements and general recommendations in chapter 6:61 Water Supply that apply.

### **Building Regulations**

#### *Water supply*

#### *General*

(Mandatory provisions)

Parts of water supply installations in contact with water shall be constructed of such materials and designed in such a way that substances hazardous to health cannot be released into the water, and so that harmful growth of micro-organisms in the water supply is prevented.

#### **General recommendation**

In order that the quantity of micro-organisms in installations where hot water is stationary (e.g. calorifiers or storage tanks) should not assume harmful proportions, the temperature of hot water in these components should be not less than 60°C.

#### *Hot water temperature*

(Mandatory provisions)

Installations for hot water shall be designed so that the temperature at the hot water tap is not less than 50°C. Installations where recirculation pipes for hot water are required in accordance with Subsection 6:613 shall be designed so that the temperature of the circulating hot water does not fall below 50°C.

This translation of the reprint of Building Regulations 94, BFS:1993:57 incl. Amendments up to BFS 1998:38, of the Swedish Board of Housing, Building and Planning contains mandatory provisions and General recommendations pursuant to the Planning and Building Act (1987:10), PBL, the Planning and Building Decree (1987:383), the Act on Technical Requirements for Construction Works etc (1994:847) and the Decree on Technical Requirements for Construction Works etc (1994:1215).

**Drinking water regulations**

In the Swedish National Food Administrations Ordinance on Drinking Water (SLV FS 1993:35) regulations and advisory notes for the quality of the drinking water can be found. This ordinance is currently under revision due to EU directive on water for human consumption

**Thermal Solar panels systems**

95% Of thermal Solar panels systems are both for heated water and hot water. Most of these systems accumulate the heated water and have a heat exchanger for the hot water. The other 5 % of the thermal solar panels systems accumulate the hot water. (Peter Kovacs at the Swedish research institute SP)

**Cases of Legionellosis in Thermal Solar panels systems**

Görel Allestam at the Swedish Center for Disease Control informed me that to the best of here knowledge there has not been any case of Legionellosis in Thermal Solar panels systems.

**Research**

To the best of my knowledge there has not been any research on solar systems including Legionella in Sweden so far.

## 6 Legionella in Belgium

Karel de Cuyper  
BBRI

Av. P. Holoffe 21 B-1342 LINELETTE, Belgium

Tel: +32 2 655 77 11

Fax: +32 2 653 07 29

E-mail: [karel.de.cuyper@bbri.be](mailto:karel.de.cuyper@bbri.be) Website: [www.bbri.be](http://www.bbri.be)

(powerpoint presentation)

### Content

0. BBRI-presentation
1. Occurrence
2. Regulations
3. Other initiatives

### 0. BBRI-Presentation

Belgian Building Research Institute (BBRI) is a private research institute created by the Belgian contractors in 1960

Staff: 200

Budget: 18.6 million EURO

- 60% contribution of contractors
- 13% income from National and EU research
- 27% sale of services

### 1. Occurrence of Legionella

| SIPH               | 1997 | 1998 | 1999 |
|--------------------|------|------|------|
| Total              | 22   | 62   | 195  |
| Travel associated  | 1    | 2    | 8    |
| Community acquired | -    | -    | 93   |
| Nosocomial         | -    | -    | -    |
| Unknown            | 21   | 60   | 94   |

Underreported:

- Only compulsory (since 1996) in one of the three Belgian Regions: Flanders;
- Hospitals seem – systematically - not to report.

Underdetected: because all pneumonia are not systematically checked on their causal agent.

Main breakout:

- General fear in Kapellen (north of Antwerp) in November 1999;
- Number of cases: 115, deaths: 5;
- Cause: whirlpool on the exhibition.

## 2. Regulations

Health is a competence of the 3 Regions in Belgium (Flanders, Wallonia and Brussels), not of the Federal Government.

For the time being there are only explicit regulations for whirlpools in public swimming pools: One check a year, 0 Legionella colonies in 500ml of water (method not specified!).

However, Belgium lives under the “code Napoleon”, which states that “one will look for a responsible in case someone suffers injury”.

This rule can be invoked because:

- The drinking water regulations state that this water shall not contain dangerous elements.
- All people responsible for public buildings were notified about the problem.

Anyhow, regulations will be issued – normally - still this year in Flanders

For:

- All buildings accessible to the public.
- With water systems that can generate aerosols.

Requiring – proposal!:-

- Cold and hot sanitary water systems to respect temperature levels:
  - Cold water < 20°C;
  - Hot water > 60°C.
- All systems to have:
  - a risk analysis;
  - a Legionella managing plan based on the risk analysis.
  - a logbook.
- The temperature requirements have to be met:
  - Within 5 years for existing buildings;
  - Before becoming operational for new buildings.
- The managing plan has to be available after 12months.
- The possibility of inspection and appreciation - at any time - by health inspectors of the measures realised or set forward. They can impose appropriate correcting measures and even the closure of the installations.

## 3. Other initiatives

- Several water supply companies do propose risk analysis.
- All academic hospitals do have continuous surveys of their installations.
- BBRI and other research institutes are conducting research on Legionella and anti Legionella actions.
- BBRI published in 1997 recommendations for lowering the risk at the level of the conception of the hot water installation.
- EWGLI (European Working Group for Legionella Infections) is working on guidelines for prevention.
- REVHA (European equivalent of ASHRAE) created a working group with aim to elaborate guidelines. Convenor: Italy.



## 7 Control of Legionellosis in the UK

**Reginald Brown  
BSRIA**

**Old Bracknell Lane UK-RG12 7AH BRACKNELL, Great Britain**

**Tel: +44 (0)1344 750515**

**Fax: +44 (0)1344 750446**

**E-mail: [reginald.brown@bsria.co.uk](mailto:reginald.brown@bsria.co.uk) Website: [www.bsria.co.uk](http://www.bsria.co.uk)**

### **General**

The regulation of health and safety in the UK comes under the Health and Safety at Work etc Act 1974. This places a general “duty of care” on both employers and employees to ensure safe working but does not itself identify specific hazards and risks. This has the advantage of allowing health and safety inspectors to react quickly to emerging risks without waiting for specific regulations to be enacted. As a result the UK was probably one of the first countries in Europe to aggressively tackle the Legionella issue and by 1991 the practical basis of control had been firmly established with the publication of code of practice and guidance documents, which remained largely unchanged until 2001.

The key element of the code of practice was the legal requirement for a risk assessment and the implementation of a control scheme based on that risk assessment. All the outbreaks which have occurred during the last 10 years have been associated with obvious failures to implement the approved code of practice<sup>i</sup> and/or the guidance<sup>ii</sup>. At present cooling systems and hot and cold water system are thought to produce similar number of cases of legionellosis. However, of the total of 200-250 recorded cases per year approximately half are believed to have been contracted outside the UK i.e. people falling ill shortly after returning from foreign holidays.

While the code of practice and guidance were clearly achieving the desired effect in reducing and maintaining relatively low levels of cases, in 1998 the Health and Safety Executive (HSE)<sup>1</sup> recommended that they should be updated to reflect:

- changes in water services technology;
- new opportunities in water treatment;
- accumulated experience and understanding of Legionella control.

### **ACOP**

The opportunity was also taken to combine the HSC approved code of practice and HSE guidance in a single document, the new Approved Code of Practice & Guidance (ACOP)<sup>iii</sup>. Industry bodies such as the Chartered Institution of Building Services En-

---

<sup>1</sup> The Health and Safety Commission is a statutory body which advises government on regulatory issues. The Health and Safety Executive is the inspection agency, though most routine Legionella inspection is delegated to the Environmental Health Departments of local councils. HSE tends to become involved directly when there are outbreaks and in the prosecution of person who have failed to comply with their duties under the Health and Safety at Work etc Act.

gineers, the Water Management Society (mainly for cooling towers) and British Associations of Chemical Specialities (water treatment suppliers) also decided to update their guidance and recommendations at this time to be consistent with the revised code.

In fact the core guidance in the ACOP is hardly changed i.e. keeping cooling systems clean and with the correct levels of biocide and applying the temperature regime to hot and cold water services. There are however several important changes including:

- Recommendations for the monitoring of Legionella – routinely for cooling towers and depending on the risk assessment for hot and cold water systems. Previously there was no recommendation for Legionella sampling except in the case of an outbreak. The emphasis was, and still is, on prevention rather than cure.
- An acceptance of low levels of Legionella in water systems. If you look for Legionellae then you are probably going to find them. Previously if any Legionella has been found, the system would have been shut down and thoroughly disinfected. Now there are action limits for both cooling systems and hot and cold water systems.
- An acceptance of alternatives to the temperature regime for hot and cold water services provided that they are thoroughly monitored. These include ionisation and chlorine dioxide.
- No minimum size of water system to which the requirements apply.

Since the whole regulatory regime exists under the Health and Safety at Work etc. Act 1974 it only applies to workplaces, though the definition of a workplace is much wider than might first appear. The ACOP does not however apply to private housing. Legionella in housing is considered indirectly in the Water Supply (Water Fittings) Regulations 1999 which are intended amongst other things to avoid deterioration of water quality between the mains supply and point of use. The provisions of the water regulations therefore consider, amongst other things, the cleanliness of the system, backflow prevention and the avoidance of materials and temperatures which could encourage bacterial growth.

One thing which should perhaps be explained about UK domestic hot and cold water systems is the prevalence of cold water storage tanks in each property. The supply cold water by gravity through a storage heat exchanger to produce hot water. Most other European countries use direct mains pressure systems for both hot and cold water. Since the storage tank is usually in the ventilated roof space, it must be insulated against both frost and solar gain. Despite the fact that such systems are potentially at higher risk of colonisation by Legionella than mains fed combination boilers (because of fluctuating temperatures and storage volumes) there are very few recorded instances of legionellosis being contracted from household hot water systems. Legionellae (originating from the mains water) are probably present in most household systems at some time but nutrient levels should be very low and the throughput of water is sufficient to prevent the build up of a hazardous concentration.

My own view of solar hot water systems is that they should be designed to achieve high temperatures for stored hot water (at least intermittently) or preferably avoid storage altogether. The danger systems are those which consistently supply warm

water which is ideal for bathing (40-45°C) but never reach a disinfection temperature. The current UK market for solar hot water is rather small (with probably only a few tens of thousand installed systems) but growing and promoted by government as part of its sustainable energy policy. The main equipment suppliers do issue clear guidance on the design and control of solar systems (in conjunction with conventional boilers) to avoid Legionella problems but this may not always be followed. It remains to be seen whether larger numbers of installed household systems will begin to reveal some problems.

Where solar water heating is installed in buildings covered by the Health and Safety at Work etc Act (virtually all buildings other than houses) it must as a water system be assessed according to the requirements of the ACOP. At present there are no specific references to solar systems in the ACOP but the general requirements will apply. This means that hot water storage and distribution must not be less than 60°C unless acceptable alternative water treatments can be applied and monitored for effectiveness.

### References

- <sup>i</sup> The prevention or control of legionellosis (including legionnaires disease). Approved code of practice L8, HSC 1991
- <sup>ii</sup> The control of legionellosis including legionnaires disease. Health and safety series booklet HS(G)70, HSE 1991
- <sup>iii</sup> Legionnaires disease: The control of Legionella bacteria in water systems: Approved code of practice & guidance L8, HSC 2000.

## 8 Legionella in Hot Tap Water Production

Hans van Wolferen  
TNO Environment, Energy and Process Innovation  
Refrigeration & Heat Pump Technology Dept.  
P.O.Box 342, 7300 AH APELDOORN, The Netherlands  
Tel: +31 55 549 37 67  
Fax: +31 55 549 37 40

E-mail: [Hans.vanWolferen@mep.tno.nl](mailto:Hans.vanWolferen@mep.tno.nl) Website: [www.mep.tno.nl](http://www.mep.tno.nl)

### Introduction

The first section of this publication contains a brief description of the Legionella bacterium, involving a characterisation of this bacterium, infection of and symptoms in human beings, and methods for detecting and controlling the bacterium. Unless stated otherwise, the text is based on a literature review performed by TNO [1] and on the Dutch Guideline ISSO 55.1 [5].

The second section is a brief overview of the Dutch regulations with respect to tap water, concentrating on hot tap water production and solar boilers.

### Legionella

#### Characteristics of Legionella

*Legionellae* are rod shaped, mobile bacteria that occur naturally in surface water and groundwater. Their length is 2 – 20 µm and their diameter 0.3 – 0.9 µm.

*Legionella* bacteria are members of the *Legionellaceae* family, with *Legionella* being the only genus. The family comprises 42 species, including *Legionella pneumophila* which is subdivided into 3 subspecies and 15 serogroups. Basically, the bacteria of these different species and serogroups show similar growth and decline behaviours.



Figure 1. *Legionella* bacteria

Factors promoting the growth of *Legionella* are:

- Water. *Legionellae* live in water; without water, they will die very quickly.
- Oxygen. *Legionellae* are aerobic bacteria; they will die very quickly in anoxic water.
- Water temperature. *Legionellae* will show growth between 20 and 50°C, with optimum growth occurring between 30 and 40°C. Above 60°C, the bacteria will die off quickly (see Fig. 2).
- Residence time. A long residence time in water at favourable temperatures may result in high concentrations of *Legionella*.
- Standstill and stagnation. *Legionella* thrives in stagnant water. Pipes or parts of an installation that have not been flushed are breeding grounds for *Legionella*.
- Acidity. *Legionella* can grow at the pH of 5.5 to 9.2, and will survive a pH of 2.2 for 5 minutes.
- Sediment and biofilm. *Legionella* requires different nutrients than other bacteria do and finds them specifically in sediment and/or biofilm. Biofilm is a slimy, algaeous deposition on parts of the installation; this deposition is composed of a random collection of bacteria, protozoa and amoebae (Fig. 3). The nutrients are procured from both the water and the inside surface of the pipe. In this biofilm, *Legionella* is more resistant to unfavourable conditions than when living free in the water. Research has shown that biofilm does not easily attach itself to stainless steel. Copper also tends to resist it. Plastics behave in various different ways. Rubber and comparable materials offer a favourable basis for biofilm and *Legionella*. Scale and sediment can overlies and thus efface the original biofilm resistant properties of the material.

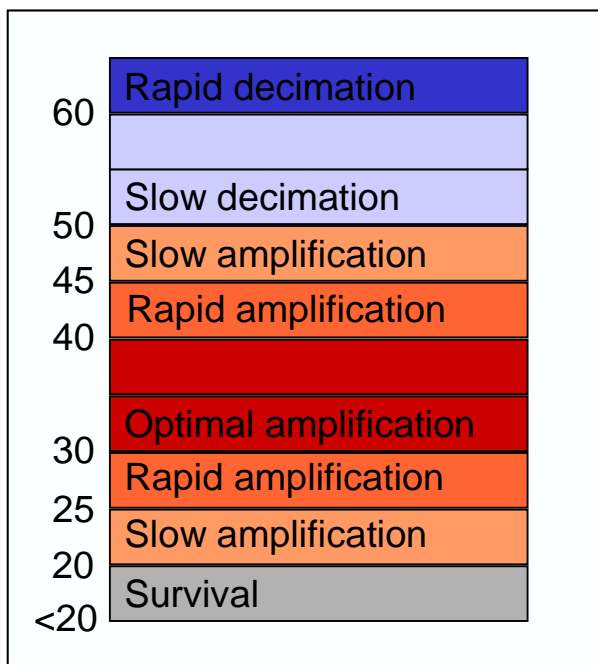

Figure 2. Growth and decline behaviours of *Legionella* are dependent on water temperature.

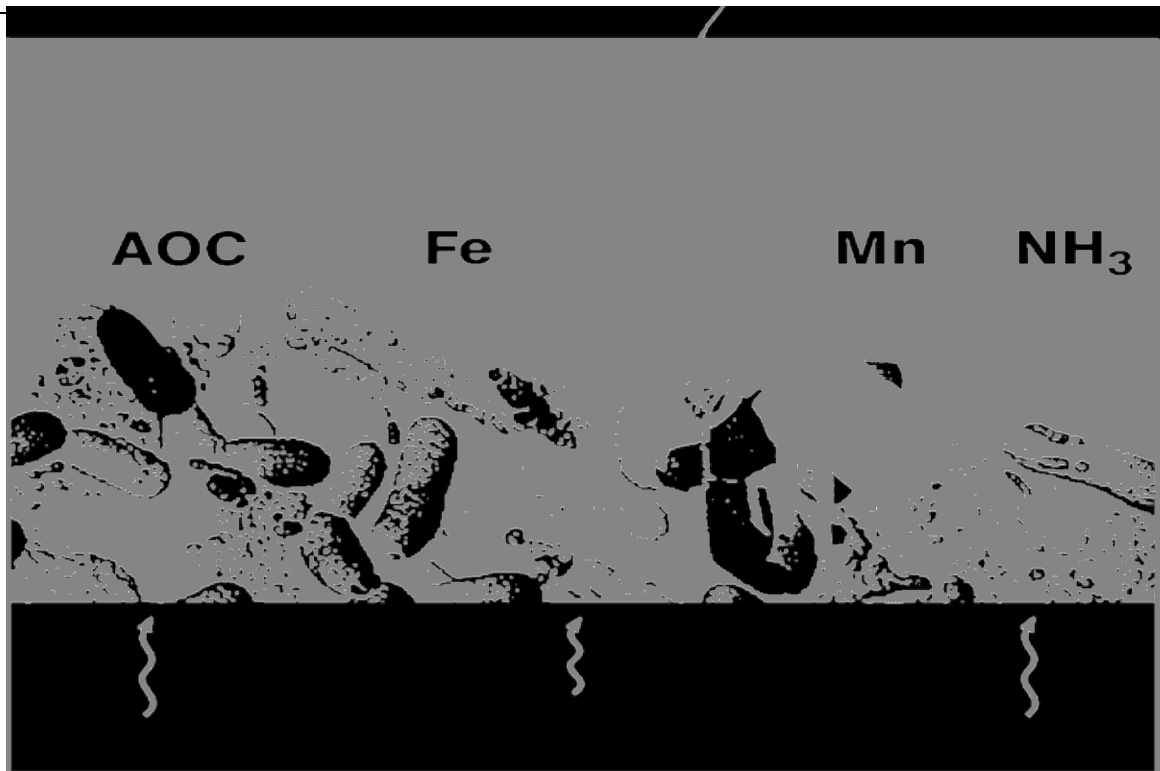

Figure 3. Impression of biofilm on inside pipe wall (with thanks to KIWA)

A special characteristic of *Legionella* is its replication within protozoa or amoebae. These single-celled organisms live in the biofilm of bacteria which they encapsulate and kill. If they encapsulate a *Legionella* bacterium, the latter will manage to behave like a parasite. The protozoa or amoebae are then eaten from the inside and filled up by a fast growing quantity of *Legionellae*, until the protozoa or amoebae burst, releasing the *Legionellae* (Fig. 4).

### Infection of and symptoms in human beings

The only known infection route is the one by which people have inhaled aerosols (mists of water) contaminated with *Legionella*. The droplets are sized between 1 and 10  $\mu\text{m}$ . The infection cannot be passed from person to person.

People with a weakened defence system are most at risk. Other factors that increase the chance of infection are elderliness, smoking and drinking. Also, the chance of infection is greater for males (by a factor of 2.5) than it is for females.

Infection can cause two separate diseases to develop:

- Pontiac Fever, an illness that is very similar to influenza and lasts for a couple of days. In many cases, the illness is not recognised as such.
- Legionnaires' disease, which has an incubation period of 2 to 10 days. The syndrome starts with flu-like symptoms, changing to a kind of pneumonia, followed by inflammation of various internal organs. Only 5 % of the infected persons develop this disease; however, of those that do, some 10 to 30 % die of it. Those who survive may suffer permanent damage to their lungs and other internal organs.

In the human body, *Legionellae* behave just as they do in the biofilm. If the bacteria are encapsulated by a macrophage (white corpuscle), they parasitize it, so that the infection spreads rapidly throughout the whole body, possibly affecting internal organs (see Fig. 4).

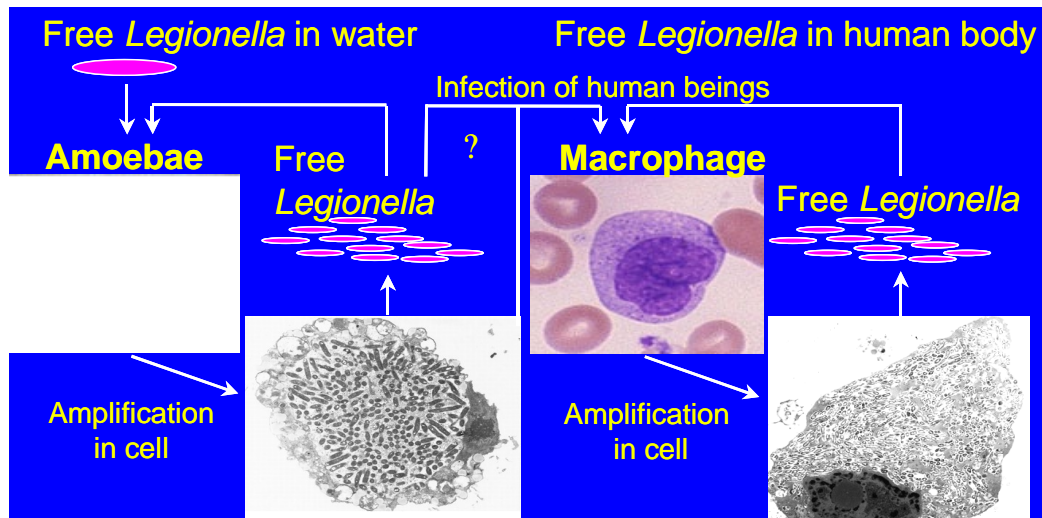

Figure 4. Replication of *Legionella* in an amoeba (at left) and in a white corpuscle/macrophage (at right).

The different types and serogroups are not all equally hazardous to human health. This is an important fact to be aware of if *Legionella* is found in an installation and, pending cleaning measures, the level of acute risk has to be assessed. However, it must also be realised that the presence of less dangerous types or serogroups indicates that the conditions are apparently favourable good for all types of *Legionella*.

### Detection

In the Netherlands, there is currently only one accepted detection method, i.e. the culture as described in NEN 6265 [2]. This method measures only the presence of living *Legionellae* with a lower limit of 50 cfu/l (cfu = colony-forming units, or concentrations of one or more bacteria that form one colony on the plate). The biggest disadvantage of this method is that it takes one to two weeks before the results are known. This is particularly problematic if patients are awaiting diagnosis and if the effects of measures in infected systems need to be assessed.

Another method is the DNA method, by means of which the DNA profile of *Legionella* can be determined within one day. This method measures both dead and living *Legionellae*. It is used, for example, to determine the serogroup and such like, as well as the origin of *Legionella*.

In addition, various quick tests are currently being developed; their quality, however, is still not quite clear.

### Control

In the Netherlands, the preferred methods for controlling *Legionella* in potable water systems are thermal prevention and disinfection. To prevent *Legionella* from occurring, the temperature should remain below 20 - 25°C (with only minor growth) or above 50°C (no growth possible). Above 60°C, *Legionella* will die, although a decimal reduction time of 2-3 minutes at 60°C should be taken into account.

Under some circumstances, control measures are applied, such as pipe flushing or water reheating. Table 1 shows how long these measures should last at various common temperatures. In determining these target times, it is assumed that the concentration can have increased to 10<sup>5</sup> cfu/l, so that a reduction by a factor of 3 is required.

| Temperature | Flushing time in case of weekly flushing | Reheating time |
|-------------|--|----------------|
| 60°C        | 20 min.                                  | 10 min.        |
| 65°C        | 10 min.                                  | 1 min.         |
| 70°C        | 5 min.                                   | 10 s.          |

Table 1. Flushing time and reheating time as functions of temperature [3].

Occasionally, higher temperatures are used. It is known, for example, that in some spas and aqua centres the pipes are cleaned every week with steam. This method is also used to disinfect systems contaminated with *Legionella* and biofilm. Here too, temperatures between 60 and 70°C are used, but at considerably longer exposure times than the ones stated in Table 1.

In addition to thermal treatment, there are various chemical and/or physical disinfection and prevention methods available. An inventory of these methods was made in a recent report [4]. Below, a survey of these methods is given, including the substances released in these processes, as applicable to potable water.

These methods must also be supplemented with control measures, both to guarantee proper operation of the equipment, and to see to it that the entire installation including all outlets is covered. Here too, dead pipes or pipes that have not been flushed may continue to be breeding grounds for *Legionella*.

| Type of treatment            | Description  | Active substances   |
|------------------------------|--|---|
| Thermal treatment            | See previous paragraph.  | None  |
| Pasteurisation               | Special execution of thermal treatment.  | None  |
| Doses of sodium hypochloride | Short term application (several hours) of high concentration<br>Continuous low concentration in the entire system. | NaOCl<br>Minimally 20 mg/l<br>Up to 5 mg/l (max. 8 mg/l)<br>This forms:<br>HOCl (pH<6.5)<br>OCl <sup>-</sup> (pH>8.5)<br>High concentrations may cause significant corrosion of copper pipes. |
| Doses of chloro-dioxide      | Short term application (several hours) of high concentration<br>Continuous low concentration in the entire system. | ClO <sub>2</sub><br>Up to 1.5 mg/l<br>Up to 0.2 mg/l<br>Residue: chloride.<br>The above doses will have only a minor effect on pipe material.   |



| Type of treatment               | Description   | Active substances  |
|---------------------------------|---|--|
| Doses of chloro-amine           | Continuous low concentration in the entire system is the most worthwhile application.   | ClNH <sub>2</sub> to 2 mg/l.<br>In this process, ammonia may be released, forming strong complexes with copper, thus possibly preventing the formation of a protective covering layer. |
| Doses of hydrogen peroxide      | Solely for short, periodic treatment, applied for maximally 24 h. It kills bacteria in the entire system.   | H <sub>2</sub> O <sub>2</sub> concentration of 200-500 mg/l.<br>At low concentrations, the effect on pipe material is minor.   |
| Anodic oxidation / electrolysis | By way of electrolysis, substances present in the water are converted into oxygen radicals, atomic oxygen, hydroxyl radicals, elementary chlorine and HOCl. This kills bacteria in the entire system. | Concentrations?<br>Organic by-products < 5 µg/l  |
| Copper/silver ionisation        | Formation of copper and silver ions by way of ionisation.   | Copper ions 100 – 400 µg/l.<br>Silver ions 10 - 40 µg/l.   |
| Membrane filtration             | Microfiltration and ultrafiltration to keep out passing bacteria.   | None   |
| UV disinfection                 | Local UV radiation kills passing bacteria.  | None   |
| Electrical pulses               | This affects the cell wall of the bacterium.  | Presumably none.   |

Table 2. Survey of alternative disinfection methods to prevent and control Legionella.

Points of attention in selecting one or more methods are:

- Toxicity for humans;
- Possible effects on the installation;
- Method (continuous / regular / occasional);
- Activity (local / entire installation);
- Control measures;
- Cost.

At this stage, it should be emphasised that there is an essential difference between methods with a local effect and those that affect the entire installation.

Local methods kill *Legionella* at one spot. This leaves the possibility of *Legionella* and biofilm growing on both sides of this very spot. Examples of such local methods are pasteurisation, membrane filtration, UV and electrical pulses.

So-called global methods affect the entire installation from the dosing point on. Examples of such methods are the majority of thermal and chemical methods.

## *Dutch Regulations For Tap Water*

### **Introduction**

In order to prevent outbreaks of infection by the *Legionella* bacteria, the Dutch government has issued a number of rules with respect to collective tap water systems. These rules have been put down in the "Temporary Directive for *Legionella* Prevention in Tap Water" issued by the Ministry of Housing, Spatial Planning and the Environment (VROM) [3], further to be referred to as the "Temporary Directive". This directive states that it is compulsory for public or collective systems to have a risk analysis for *Legionella* prevention performed and, if necessary, to draft a control plan. Tap water comprises the following 'types' of water: drinking water, hot tap water and water for domestic use. As a result of the Temporary Directive, ISSO publication 55.1 "Guide for *Legionella* Prevention in Tap Water" was developed [5], further to be referred to as the "Guide". This Guide contains tools and regulations for conducting a risk analysis and drafting a control plan that can be applied to all tap water systems. The guide follows ISSO publication 55 'Tap Water Systems in Domestic and Utility Buildings'. A large number of measures have already been described in the Vewin<sup>2</sup> guidelines [6], but some points have been stepped up.

The rules for individual systems are set only by NEN 1006, a standard that is currently being adapted. For more complex systems, such as solar boilers, the draft text refers to the risk analysis as described in the Temporary Directive. In all cases, alternative approaches are permitted, provided they produce equal results (no risk). Directives for *Legionella* prevention are also available abroad. Two examples are the directives issued by ASHRAE [7] and CIBSE [8]. The Temporary Directive and the ISSO Guide are briefly summarised below.

### **The Temporary Directive**

The Temporary Directive was put into force on 15 October 2000, and will be valid for maximally two years. The Directive will then be converted into long term legislation. The Temporary Directive contains, among other things, the following stipulations (for the sake of readability, a free interpretation of the text is given here; for the verbatim text, the reader is referred to the actual directive):

- Tap water should not contain any demonstrable quantity of *Legionella* bacteria at the taps. The current methods use a detection limit of 50 colony-forming units (cfu) per litre. This stipulation applies solely if the water can be used in such a way that aerosols are formed and there is a situation in which people can inhale these aerosols, as is the case with showers.
- The owner of a collective water supply system or a waterworks is responsible for ensuring that the tap water supplied by him meets the requirements set.
- In order to assess whether the requirements are met, the owner must have a risk analysis performed every three years. In case of changes to the plant, the risk analysis must be performed again within three months after the change.
- If the risk analysis shows the necessity of control measures, the owner should have a control plan drawn up.

---

<sup>2</sup> Vewin = Dutch Water Association

- The owner executes control measures in accordance with the control plan. Measures and checks should be recorded in a logbook.
- The risk analysis and the control plan must be recorded in writing and remain available, together with the logbook, for the supervisor's perusal.

Directives for performing a risk analysis and drafting a control plan are given in two appendices. The explanation also contains the recommended sampling frequency. The basis for the risk analysis is risk qualification; for this, the symbols of Table 3 are used.

| Symbol | Meaning                          |
|--------|----------------------------------|
| 0      | Neutral<br>< 50 cfu/l (absolute) |
| +      | Reduction with a factor of 10    |
| ++     | Reduction with a factor of 100   |
| +++    | Reduction with a factor of 1000  |
| -      | < 10 <sup>3</sup> cfu/l          |
| --     | < 10 <sup>4</sup> cfu/l          |
| ---    | < 10 <sup>5</sup> cfu/l          |

Table 3. Symbols for risk qualification.

The combination of temperature and duration determines the risk qualification for parts of the installation, as stated in Table 4.

| Risk factors     |                                      |  |                                       |  |                                      |  |
|------------------|--------------------------------------|--|---------------------------------------|--|--------------------------------------|--|
| Temperature (°C) | Duration of temperature in component | Risk qualification (+ dying off; - growth) | Duration of temperature and component | Risk qualification (+ dying off; - growth) | Duration of temperature in component | Risk qualification (+ dying off; - growth) |
| < 20             | Unlimited                            | 0  |                                       |  |                                      |  |
| 20 – 25          | Unlimited                            | 0  |                                       |  |                                      |  |
| 25 – 45          | < 2 days                             | 0  | > 2 days<br>< 1 week                  | -  | > 1 week                             | ---  |
| 45 – 50          | Unlimited                            | --   |                                       |  |                                      |  |
| 50 – 55          | Unlimited                            | 0  |                                       |  |                                      |  |
| 55 – 60          | > 1 hour                             | +  | > 2 hours                             | ++   | > 3 hours                            | +++  |
| 60 - 65          | > 3 min                              | +  | > 5 min                               | ++   | > 10 min                             | +++  |
| 65 - 70          | > 20 sec                             | +  | > 40 sec                              | ++   | > 1 min                              | +++  |

Table 4. Risk qualification as a function of temperature and duration. For pipe volumes < 1 litre, the risk qualification is neutral (0).

### Practice Guideline ISSO 55.1

The objective of the ISSO guide is to achieve demonstrably *Legionella* safe tap water systems that meet the standards set forth in the Temporary Directive.

### Method

In order to conduct a risk analysis, one of the following methods must be chosen:

- Limited risk analysis.

A limited risk analysis solely considers whether aerosols can be formed at the taps and whether people are exposed to this in such a way that a hazardous situation may arise if the water contains high concentrations of *Legionella*. Therefore, this method does not reveal whether or not the tap water contains *Legionella*. The only question it answers is whether people will be at risk by being exposed to "relevant quantities of inhalable aerosols". This method is particularly suitable for systems with (practically) no taps where relevant quantities of inhalable aerosols can be formed.

- Extensive risk analysis.

An extensive analysis covers the entire system – from raw material (intake of tap water) to the taps – in order to determine whether situations can occur in which *Legionella* can attach itself and develop to detectable concentrations. The risk qualification is specifically based on the combination of duration and temperature of system parts.

Dutch potable water is not chlorinated and contains only few bacteria (probably 1 cfu *Legionella* / 2500 l, but possibly occasionally higher).

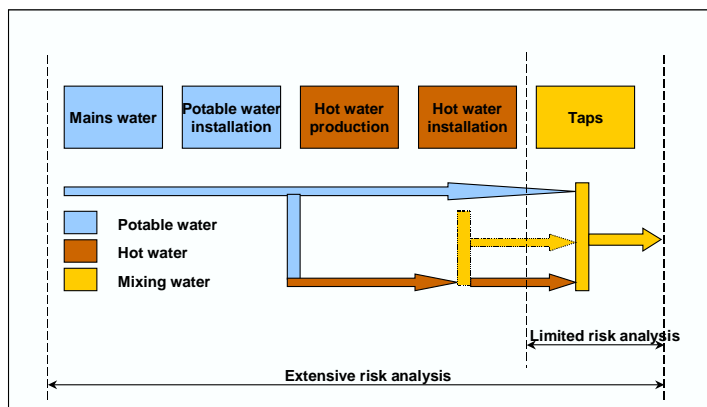

Figure 5. Main functions of the installation to which the risk analysis is applied.

### Limited risk analysis

The objective of this analysis is to assess the extent to which relevant quantities of inhalable aerosols can be formed when taps are used that are part of a water system or connected to it.

For the risk analysis, the following data are collected per tap:

- number of taps (on drawing or floorplan of building);
- location of taps (description of the room);
- type of tap (e.g., sink, washbasin, bath, shower, toilet, fire-hose);
- water connection: domestic water, potable water and/or hot water;
- relevant aerosol formation (the Guide gives directives per type of tap);
- preventive measures (only required in case of possible relevant aerosol formation).

**Extensive risk analysis**

For the risk analysis, the tap water installation is divided into five main functions (Fig. 5). The analysis shows whether there is a chance of growth of possibly present *Legionella* bacteria in each of these main functions. The installation is considered safe only if this chance is nil for all functions.

Two tools have been developed for simple risk determination in regularly recurring situations:

- checklists for the five main functions (example in Appendix 1);
- a survey of frequently occurring components with a risk rating for their various applications (example in Appendix 2).

For the risk analysis, data are collected with respect to:

- the installation;
- the ambient temperatures of the installation;
- the operation and the use of the installation.

The risk analysis consists of the following steps:

- for every main function, the tap water system is subdivided into separate components;
- risk analysis per component;
- risk analysis per main function and for the entire system.

In the majority of cases, these data make it possible to reduce the entire installation to a number of frequently used (components of) tap water systems whose risk level has already been ascertained. In these cases, it is not necessary to examine the installation; the risk analysis can be copied from the Guide.

The risk analysis for the entire system is based on the risk analysis per main function. The general rule that applies here is: *Each main function must be completely risk-free. A high risk level in one function can therefore in no way be compensated for by a lower risk level in another.*

**Action to be taken following risk analysis**

The risk analysis may reveal a number of problem areas that may facilitate undesired *Legionella* growth. These problems can be solved in two ways, i.e:

- by making changes in the system;
- by applying control measures.

In addition to this, of course, system changes may be necessary to make control measures possible.

In a number of cases, a problem can be solved via both approaches. In these cases, the costs, among other things, will determine which of the two approaches is chosen. In general, changes in the system are preferred as they provide a more structural solution. For temporary situations, however, control measures may be preferred.

The remaining risk should be dealt with via control measures. The following types of measures are used for this:

- a check-up on the proper functioning of the system;
- measures to prevent *Legionella* growth;
- changes in the control plan due to changed system use;
- corrective measures, if *Legionella* is found in the system.

The checklists and the component assessment will immediately show the most desired or required control measures. This will produce a list of possible measures.

### The control plan

The control plan must, first of all, state clearly to which system it applies (name, address and nature of company or institute), the person responsible for taking action, and the person authorised to do so.

It is drafted on the basis of the data produced by the risk analysis. Among these data will be a list of possible control measures. The control plan arranges the control measures per system component and frequency (for example, weekly, monthly, yearly).

The control plan must further identify the person(s) to whom tasks and authority have been assigned per (group of) control measure(s).

It must also state which measures will be taken if and when the number of 50 cfu/l *Legionella* bacteria is exceeded. In all cases, the supervisor will be informed about such an exceedance

### Management

On the basis of the control plan, a logbook is kept in which is recorded who took which measures when. For this, forms such as the one in Fig. 6 can be used. The Guide contains an appendix with a detailed description of how to set up a control plan and logbook.

|                          |                                |                          |         |                         |  |
|--------------------------|--------------------------------|--------------------------|---------|-------------------------|--|
| Sort                     | <i>Temperature measurement</i> |                          |         |                         |  |
| Frequency                | <i>Once a week</i>             |                          |         |                         |  |
| Person                   | <i>Van Wolfereen</i>           |                          |         |                         |  |
| Control measures         |                                |                          |         | Execution               |  |
|                          |                                |                          |         | Date: <i>28-03-2001</i> |  |
| Description              | Code / location                | Instruction / req. value | Remarks | Initials                | Result / remarks                         |
| <i>Outlet appliance1</i> | <i>TF</i>                      | <i>&gt; 65°C</i>         | -       | <i>vW</i>               | <i>67 °C</i>                             |
| <i>Return hot water</i>  | <i>TR</i>                      | <i>&gt; 60 °C</i>        | -       | <i>vW</i>               | <i>63 °C</i>                             |
| <i>Potable water</i>     | <i>T1-T10</i>                  | <i>&lt;=25 °C</i>        | -       | <i>vW</i>               | <i>Tmax: 17 °C</i><br><i>Tend: 12 °C</i> |
|                          |                                |                          |         |                         |  |

Figure 6. Example of form for logbook.

**Example of Risk Analysis for Solar Boiler**

Fig. 7 shows the diagram of a type of solar boiler that is frequently used in the Netherlands. Reheating is done by way of an instantaneous or storage water heater.

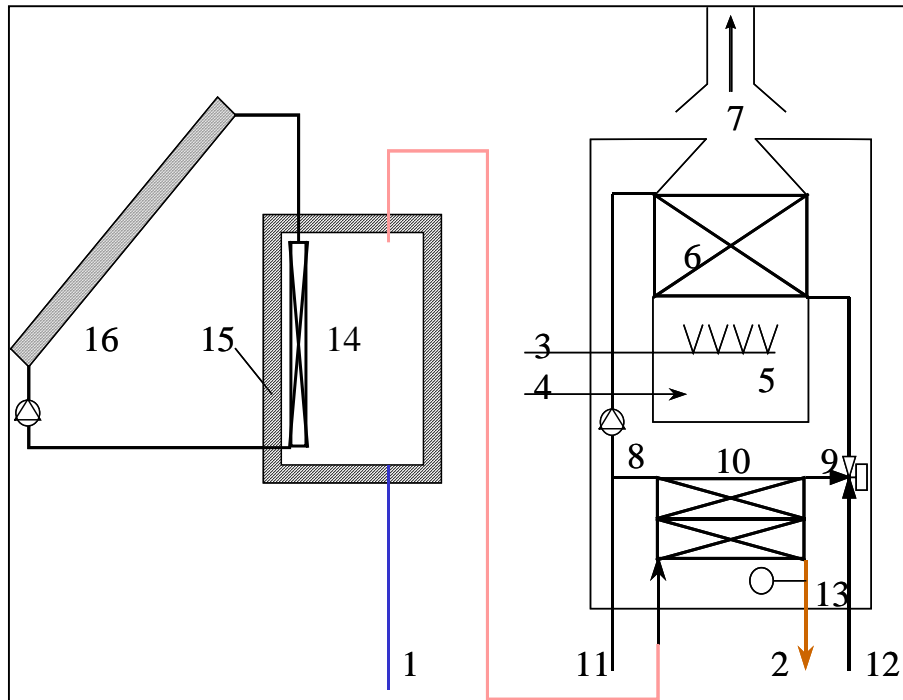

Figure 7. Solar boiler with instantaneous after heater

In the risk analysis, the risk is first determined for each separate appliance; next, the risk is determined for the entire hot tap water production in conformity with the rules for "boilers in series without charging system".

The risk of the solar boiler is determined by the temperature – duration which depend mainly on the combination of solar heat, tap water use, vessel volume, and vessel losses. On the basis of general data, two extreme operating situations can be imagined:

- Sunny/summer. There is so much sunshine in proportion to the tap water use that temperatures above 60 °C are reached in the entire vessel almost daily.
- Cloudy/winter. In case of little solar heat, a temperature between 20 and 50 °C will be reached in large parts of the vessel. If the temperature, specifically at the bottom, remains above 25 °C for a long period of time, a situation arises that is essentially favourable for the settlement and growth of *Legionella*.

Therefore, the worst situation is most likely to occur in winter, when a temperature favourable for *Legionella* may occur for a longer period of time. In the summer, on the other hand, temperatures high enough to kill all micro-organisms in the entire water storage will occur regularly.

On the basis of the Temporary Directive, such an appliance could be assessed with – to ---, if no further data are known.

In instantaneous after heaters, set at 60°C, the residence time is too short for the bacteria to be killed so that this does not offer compensation.

In applying storage heaters as after heaters, a maximum extermination (+++) can be reached at a setting above 60 °C after a residence time of 10 min. However, features are then required that guarantee that these conditions are met under all circumstances.

In order to achieve safe solar boilers, various solutions are possible.

In the thermal approach, the vessel is provided with a heating element at the bottom that can heat up the entire vessel to 60 °C if the temperature has reached undesired values for too long.

Another approach, which has been proposed by manufacturers, focuses on a clean construction of the vessel so that micro-organisms can find no breeding ground. In such a design, the vessel is made of stainless steel, with smooth links and joints, no rubber rings, etc, and an optimal flow through the vessel. This appliance would have to be drained each year to remove any sediment from the bottom. It is not clear whether or not descaling would be required; this has yet to be investigated.

In order to assess the adequacy of this alternative approach, tests in which artificial contamination with *Legionella* and biofilm will be examined, are currently being considered.



**Literature**

*Legionella* in warmtapwatersystemen, deel 1 – warmtapwatersystemen (R99/151)  
[*Legionella* in Hot Tap Water Systems, Part 1 – Hot Tap Water Systems (R99/151)]  
J. van Wolferen, Ph. van Dalen, B.J. Hartog  
TNO, Apeldoorn, The Netherlands, October 1999

NEN 6265. Onderzoek naar de aanwezigheid en het aantal kolonievormende eenheden van *Legionella*-bacteriën  
[NEN 6265. Research into the Presence and the Number of Colony-Forming Units of *Legionella* Bacteria]  
NEN, Delft, The Netherlands

Tijdelijke regeling *Legionella* preventie in leidingwater  
[Temporary Directive for *Legionella* Prevention in Tap Water]  
Ministry of Housing, Spatial Planning and the Environment (VROM), 13 October 2000

Alternatieve technieken voor *Legionella* preventie: kenmerken en beoordeling  
[Alternative Techniques for *Legionella* Prevention: Characteristics and Assessment]  
Paul Buijs c.s.  
Kiwa, Nieuwegein, The Netherlands, November 2000

ISSO 55.1 - Handleiding *Legionella* preventie in leidingwater  
[ISSO 55.1 – Guide for *Legionella* Prevention in Tap Water]  
ISSO, Rotterdam, The Netherlands, 2000

Vewin werkbladen  
[Vewin (Dutch Water Association) Guidelines]  
Vewin, Rijswijk, The Netherlands, 2000

ASHRAE Guideline 12-2000 – Minimising the Risk of Legionellosis Associated with Building Water Systems ASHRAE, Atlanta, GA, USA, 2000

CIBSE TM13:2000 - Minimising the Risk of Legionnaires' Disease  
CIBSE, London, UK, October 2000

The author has been involved in drafting the risk analysis model for the Temporary Directive and is an observer for ISSO publication 55.1.

**Appendix 1, Example of ISSO 55.1 Checklist**

**Hot Tap Water Production Checklist (appliances)**

If hot tap water is prepared at several separate locations, the following steps should be taken per set-up location.

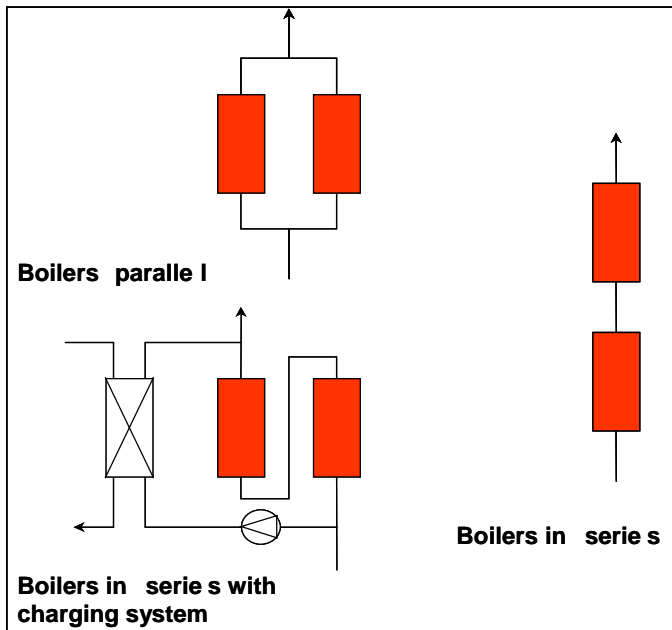

Figure B5.1 gives a number of set-up possibilities.

| Data of hot tap water production (1)              |  | General data                        |
|---|--|-------------------------------------|
| Concerns  | Answer   | Assessment & action                 |
| Set-up location                                   |  | n.a.                                |
| Number of appliances                              |  | n.a.                                |
| Set-up of appliances (in case of more appliances) | N.a.<br>Parallel<br>Series without charging system at uniform temperature<br>Series without charging system at various temperatures<br>Series with charging system<br>Otherwise, i.e.: | See Appendix 6<br>(here Appendix 2) |

Figure B5.1. Various set-up possibilities.

The following data should be given for each appliance.

| Data of hot tap water production (2)  | Data per appliance                 |    |        | Assessment & action                     |
|---|------------------------------------|----|--------|---|
| Appliance serial number, brand, type, year of construction  | Type of appliance (see Appendix 6) |    |        |   |
| 1. ...  |                                    |    |        | n/a                                     |
| Data of temperatures  | Value                              |    |        |   |
| Temperature setting: continuous or periodical   |                                    |    |        |   |
| Temperature setting(s) (°C)<br>(Vewin WB 4.4A, art 4.5 requires min. 60°C)  |                                    |    |        |   |
| Temperature measured at outlet (°C)<br>(at maximal flow for instantaneous heaters)  |                                    |    |        |   |
| Temperature measured in <i>return pipe</i> in case of circulation system.<br>(Vewin WB 4.4A, art 4.6. requires min. 60°C) |                                    |    |        |   |
| Data readers  | na                                 | ok | Not ok |   |
| Readable thermometer at appliance outlet  |                                    |    |        | <i>If "not ok", install feature.</i>    |
| Readable thermometer on return pipe of appliance in case of circulation system.   |                                    |    |        | <i>If "not ok" install feature.</i>     |
| Conclusion per appliance  |                                    |    |        |   |
| Risk assessment, if action is taken   |                                    |    |        | <i>See Appendix 6 (here Appendix 2)</i> |

If risk assessment and control measures have been performed for all appliances, the risk assessment can be made for the entire hot water production.

| Data for hot tap water production   | Risk assessment |
|-------------------------------------|-----------------|
| Risk assessment, if action is taken |                 |

## Appendix 2, Example of Component Description and Assessment from ISSO 55.1

### Component

#### Storage heaters

- Directly heated storage vessels (gas or oil boiler);
- Electric boiler;
- Indirectly heated storage vessel;
- Storage vessel without heating features (part of charging system).

#### Preconditions

See Checklist Hot Tap Water Production.

#### Assessment

| Temperature setting and tap use                                | Assessment     |
|--|----------------|
| 25 to 45°C. Daily thermal disinfection                         | 0              |
| 25 to 45°C. Weekly thermal disinfection (see guidelines below) | - <sup>1</sup> |
| 25 to 45°C. No thermal disinfection.                           | ---            |
| 45 to 50°C.  | --             |
| > 50°C.  | 0 <sup>2</sup> |

#### Notes:

- In case of weekly preventive thermal disinfection, *Legionella* may occasionally occur in concentrations above the detection limit. If this happens, there is no reason to expect high concentrations.
- A temperature  $\geq 60$  °C is recommended.

Guidelines for weekly thermal disinfection of storage vessels.

| Temperature | Required duration |
|-------------|-------------------|
| 60°C        | 20 minutes        |
| 65°C        | 10 minutes        |
| 70°C        | 5 minutes         |

#### Note:

The duration required is counted from the moment that the entire storage has reached the desired temperature. If thermal stratification occurs in the storage, the temperature at the bottom of the vessel should be used as reference temperature for the duration.

| Assessment                             | 0              | +           | ++          | +++         |
|--|----------------|-------------|-------------|-------------|
| Temperature setting and residence time |                |             |             |             |
| 55 to 60°C. Residence time:            | $\leq 1$ hour  | $> 1$ hour  | $> 2$ hours | $> 3$ hours |
| 60 to 65°C.                            | $\leq 3$ min.  | $> 3$ min.  | $> 5$ min.  | $> 10$ min. |
| 65 to 70°C.                            | $\leq 20$ sec. | $> 20$ sec. | $> 40$ sec. | $> 1$ min.  |

## Notes:

- If the purpose of a storage vessel is also to neutralise any *Legionella* growth in preceding vessels by after heating (thermal disinfection), it should be guaranteed that the water remains in the vessel for minimally the required time at the given temperature. Under no condition may a shorter residence time and/or a lower temperature occur.
- In all storage vessels, thermal stratification may occur, with the temperature at the bottom lower than the temperature at the outlet and/or near the thermostat. This effect is largest in indirectly heated boilers and electroboilers, in which the heat exchanger or the heating element is placed at a high point, and thus relatively far away from the bottom. This effect may also occur in so-called “wet-foot” boilers. If this effect occurs, there will be little or no *Legionella* extermination in the lower layers of the vessel. If no data are known, a temperature difference of 5 °C between temperature reader and vessel bottom should be assumed.
- Insufficient charging of boilers may also result in there being a zone with permanently lower water temperatures.
- During peak hours, a temporary drop in temperature may occur. In most cases, this is permissible, as long as the water reaches the set temperature for one or more hours daily. However, it is not permitted if a vessel is used as after heater for thermal disinfection (see first note).

*System changes*

Appliances that cannot supply the required temperatures should either be adapted or replaced.

*Control measures*

- Weekly measurement and recording of temperatures at outlet and return (manually or by way of BEMS).
- Weekly thermal disinfection, if applicable (manually or by way of BEMS).
- Annual control of proper working of temperature setting.
- Annual calibration of temperature readers.
- Annual sediment removal by draining at the bottom [2].

*Component*

**Hot tap water production: instantaneous storage water heaters with minimum content.**

*Preconditions*

See Hot Water Tap Production Checklist.

## Assessment

| Temperature setting and tap use | Assessment |
|---------------------------------|------------|
| 25 to 50°C.                     | -          |
| > 50°C                          | 0          |

| Assessment                             | 0          | +         | ++        | +++       |
|--|------------|-----------|-----------|-----------|
| Temperature setting and residence time |            |           |           |           |
| 55 to 60°C. Residence time:            | <= 1 hour  | > 1 hour  | > 2 hours | > 3 hours |
| 60 to 65°C.                            | <= 3 min.  | > 3 min.  | > 5 min.  | > 10 min. |
| 65 tot 70°C.                           | <= 20 sec. | > 20 sec. | > 40 sec. | > 1 min.  |

## Notes:

- Considering the short residence time of water in instantaneous storage water heaters, they should not be used as after heaters for thermal disinfection at temperatures below 65°C.
- For normal use, a temperature setting below 60 °C is not advisable.

*System adaptation*

Appliances that cannot supply the required temperatures should be adapted or replaced.

*Control measures*

- Weekly measurement and recording of temperatures at outlet and return, if appliance is part of circulation system (manually or by way of BEMS).
- Annual control of proper operation of temperature setting.
- Annual calibration of temperature readers, if appliance is part of circulation system.

*Component*

**Hot tap water production: assessment of set-up with various hot tap water appliances.**

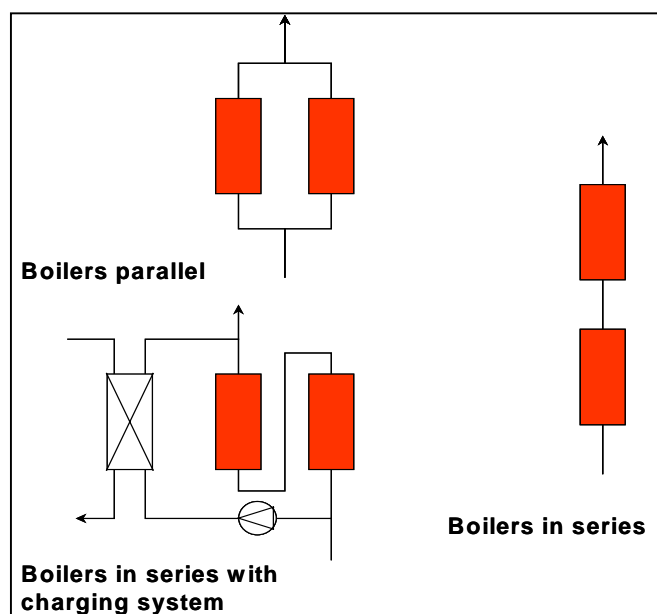
*Diagram*

*Preconditions*

See Hot Tap Water Production Checklist.

*Assessment*

| Type of set-up                 | Assessment  |
|--------------------------------|---|
| Parallel                       | Each appliance should have a neutral (0) or positive (+) risk rating.   |
| Series with charging system    | Each appliance should have a neutral (0) or positive (+) risk rating.   |
| Series without charging system | A possibly negative risk rating of the first appliance can be compensated by an equally or more positive risk rating of the second appliance. This is specifically important if the first appliance is a low temperature boiler (e.g. heated by a heat pump or solar boiler). |

Example of risk rating for two appliances in series, without charging system.

| Rating of first appliance | Rating of second appliance | Total rating | Total Rating |
|---------------------------|----------------------------|--------------|--------------|
| 0                         | 0                          | 0            | Neutral      |
| -                         | 0                          | -            | Insufficient |
| -                         | +                          | 0            | Neutral      |
| --                        | +                          | -            | Insufficient |
| --                        | ++                         | 0            | Neutral      |
| ---                       | ++                         | -            | Insufficient |
| ---                       | +++                        | 0            | Neutral      |

*Note:*

The positive assessment of the second appliance assumes sufficient residence time of the water at the set temperature. The system should be designed in such a way that this requirement is met at all times.

If due to an abnormally large demand, the water from the first boiler flows to the taps without being sufficiently heated in the second boiler, this requirement is not met.

*Control measures*

See the measures stated for the individual appliances.

## 9a Bacterial growth in solar heating prepared and traditional tanks

M.Sc. Ph.D. Lene Karen Bagh  
Rovesta Miljø I/S  
Betonvej 12, DK-4000 ROSKILDE, Denmark  
Tel: +45 4677 3794  
Fax: +45 4677 3795  
E-mail: [lkb@rovesta.dk](mailto:lkb@rovesta.dk) Website: [www.rovesta.dk](http://www.rovesta.dk)

M.Sc. Klaus Ellehauge  
Danish Technological Institute  
Teknologiparken, DK-8000 ÅRHUS C, Denmark  
Tel: +45 7220 1370  
Fax: +45 7220 1019  
E-mail: [klaus.ellehauge@teknologisk.dk](mailto:klaus.ellehauge@teknologisk.dk) Website: [www.solenergi.dk/center/](http://www.solenergi.dk/center/)

### Abstract

In Denmark it has been put forward that the introduction of solar heating prepared tanks into the building regulation can cause increased nuisance with respect to bacterial growth in hot water for domestic use. The reason is that solar heating prepared tanks have a larger volume and another form of operation than traditional tanks. In this investigation the difference between bacterial growth in solar heating prepared and traditional tanks was measured by heterotrophic plate counts as a general parameter for microbiological growth. There was no significant difference between the bacterial number in the solar heating prepared tanks and in the traditional tanks, either for bacteria determined at 37 °C, 44 °C, 55 °C or at 65 °C. The hot water for domestic use from the solar heating prepared tanks and the traditional tanks had in most cases a bacterial number below 1.000 CFU/ml, and all tests had a bacterial number below 10.000 CFU/ml. The number of bacteria must be considered low seen in relation to the other measurements of bacteria in hot water for domestic use, particularly in larger block of flats.

### Introduction

It has been proposed to introduce solar heating prepared tanks into the Danish Building regulations. This would result in the introduction of solar heating prepared tanks into all smaller houses which could cause increased nuisance with respect to bacterial growth in hot water for domestic use. The reason is that solar heating prepared tanks have a larger volume and another form of operation than traditional tanks which could promote bacterial growth.

The problematic concerning bacterial growth in hot water systems is already well known (Ovesen *et al.* 1994; Bagh *et al.* 1995; Bagh 1998; Bagh *et al.* 1999). The problems include bad smell, muddy water, reduced heat transmission and bath re-



lated skin problems. These problems can in some cases be connected with a high number of bacteria. The occurrence of *Legionella* is also of concern in hot water systems. *Legionella pneumophila* is the bacterium associated with Legionnaires' disease and Pontiac fever. Legionnaires' disease is a severe pneumonia, which can cause death to immuno-suppressed persons and Pontiac fever is a non-pneumonia, flu-like disease. The problems associated with *Legionella* is frequently observed in hot water systems in larger buildings such as hospitals and hotels but the knowledge of the occurrence of the bacterium in smaller households is limited.

The previous studies carried out by the Danish Building Research Institute have focussed on larger block of flats, and there are only a few studies on the microbiological water quality in smaller households (Ovesen *et al.* 1994; 1997). In larger block of flats without solar heating there has often been found a high number of bacteria, and in many cases there has been measured a number of bacteria over 10.000 and 100.000 CFU/ml (Colony-Forming Units).

The objective of this investigation was to study the number of bacteria in smaller households in order to conclude whether solar heating prepared tanks gave rise to an increased number of bacteria in the water compared to traditional tanks. The difference between bacterial growth in solar heating prepared and traditional tanks were measured by heterotrophic plate counts as a general parameter for microbiological growth.

## **Materials and methods**

### *Investigation site*

The microbiological study was carried out by investigation of water samples from solar heating prepared tanks and traditional tanks from smaller households in October and November 1998. For the study 12 solar heating prepared tanks and 12 traditional tanks were selected. From each hot water tank there were all in all taken two water samples. The samples were taken with a few weeks interval and analysed for the number of bacteria. The tanks were geographically scattered on Zealand thus taking samples from different waterworks.

### *Hot water tanks*

All hot water tanks were 2-3 years old and most of them were enamelled. A solar heating prepared tank with a different coating did, however, take part in the study. The solar heating prepared tanks and the traditional tanks were from different manufactures such as Aidt Miljø A/S, Metro Therm A/S, Nilan A/S, ARCON Solvarme A/S and Batec A/S.

### *Bacterial Analysis*

The number of bacteria was enumerated by heterotrophic plate counts (HPC) by the spread plate procedure with R2A agar after an incubation period of 7 days (Reasoner and Geldreich, 1985). The results were obtained by heterotrophic plate counts at 37 °C and 44 °C (mesophilic bacteria) and at 55 °C and 65 °C (thermophilic bacteria) according to the proposal for Danish Standard "Determination of aerobic bacterial numbers in hot water for domestic use".

## Results

In general the solar heating prepared tanks had at least a volume twice as big as the traditional tanks, see table 1. The consumption of hot water was according to previous studies set to 46 l/pers.\*d (Bechmann, 1996), whereby the residence time in the solar heating prepared tanks became twice as long as in the traditional tanks.

| Storage tanks                         | Solar prepared tanks | Traditional tanks |
|---------------------------------------|----------------------|-------------------|
| Number of investigated tanks          | 12                   | 12                |
| Capacity (litres)                     | 231                  | 104               |
| Consumption of hot water (litres/day) | 150                  | 134               |
| Duration of water in tanks (hours)    | 39                   | 23                |
| People per household                  | 3,6                  | 2,9               |

*Table 1. Data from the tested tanks. Average consumption of hot water and residence time in the tanks was based on a daily consumption of hot water of 46 l/persons\*day.*

The number of bacteria was very low in the first and the second test round both in the solar prepared tanks and in the traditional tanks, and bacterial counts over 10.000 CFU/ml were not measured. In most of the tests there was only a minor fluctuation in the bacterial numbers from the two measurements, which is shown for bacterial counts at 37 °C in figure 1. The main conclusion has thus been made on the basis of all bacterial counts determined in tests from the solar heating prepared and the traditional tanks, respectively.

The bacterial number was not higher in the solar heating prepared tanks than in the traditional tanks, either for bacteria determined at 37 °C, 44 °C, 55 °C or at 65 °C.

The hot water for domestic use from the solar heating prepared tanks and the traditional tanks had in most cases a bacterial number below 1.000 CFU/ml, and all tests had a bacterial number below 10.000 CFU/ml (Figure 2,3). The number of bacteria must be considered low seen in relation to the other measurements of bacteria in hot water for domestic use, particularly in larger block of flats.

From figure 2 it can be seen that most solar heating prepared tanks had a bacterial number between 100 and 1.000 CFU/ml, and only a few percent, particularly at the higher incubation temperatures, had a bacterial number higher than 1.000 CFU/ml.

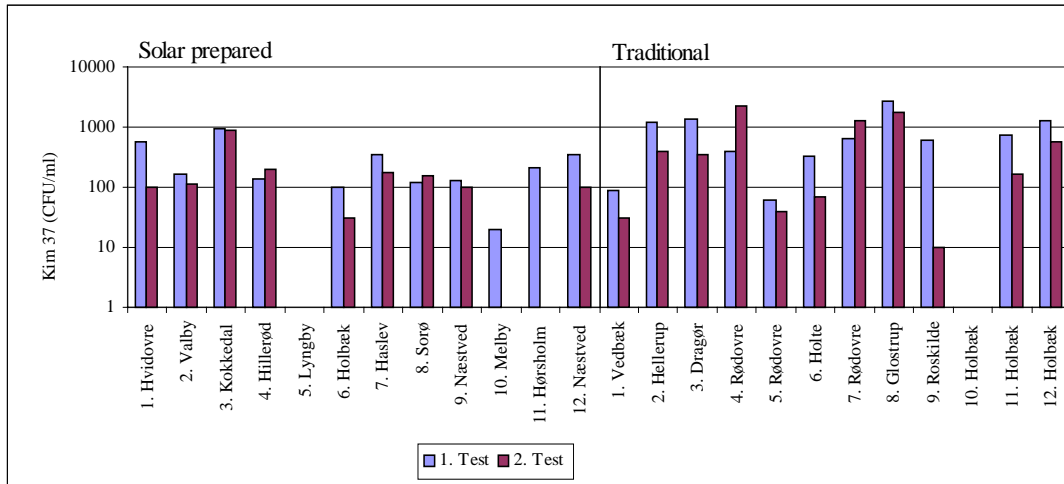

Figure 1. Bacterial numbers cultivated at 37 °C in solar heating prepared tanks and traditional tanks.

Measurement results have been stated from both 1. and 2. measuring. Values with the designation <10 and <100 CFU/ml have not been included

In the traditional tanks the bacterial numbers were likewise very low (Figure 3). However, a larger percentage of traditional tanks had a bacterial number higher than 1.000 CFU/ml than in the solar heating prepared tanks, especially at an incubation temperature of 44°C.

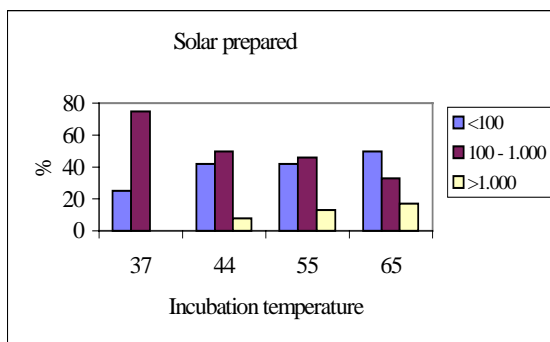

Figure 2. The percentage distribution of bacterial counts at different incubation temperatures in solar heating prepared tanks. The bacterial numbers have been grouped into < 100 CFU/ml, between 100 and 1.000 CFU/ml and > 1.000 CFU/ml.

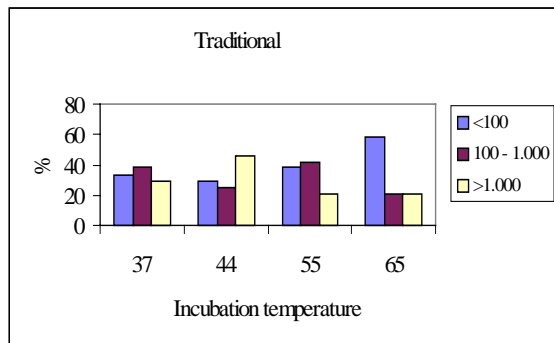

Figure 3. The percentage distribution of bacterial counts at different incubation temperatures in traditional tanks. The bacterial numbers have been grouped into < 100 CFU/ml, between 100 and 1.000 CFU/ml and > 1.000 CFU/ml

Most bacterial counts were below 1.000 CFU/ml irrespective of which incubation temperature was used to determine the bacterial numbers. The average bacterial counts in the tests from the traditional tanks were slightly higher than the ones from the solar heating prepared tanks, but they were still very low, see table 2.

| Storage tanks      | Solar prepared tanks | Traditional tanks |
|--------------------|----------------------|-------------------|
| HPC 37 °C (CFU/ml) | 210 (960)            | 690 (2700)        |
| HPC 44 °C (CFU/ml) | 290 (1400)           | 1351 (7200)       |
| HPC 55 °C (CFU/ml) | 400 (1700)           | 830 (5700)        |
| HPC 65 °C (CFU/ml) | 627 (6600)           | 1087 (6900)       |
| pH                 | 7,9 (8,3)            | 7,9 (8,1)         |
| Temperature (°C)   | 51 (69)              | 50 (60)           |

Table 2. Average heterotrophic plate counts (HPC) and maximum values, pH and water temperatures from the investigations of solar heating prepared tanks and traditional tanks.

## Conclusions

It was not possible to spot a water quality deterioration, even though the solar heating prepared tanks on average had a volume 2.2 times as big as the traditional tanks, and the water had a longer residence time in the solar heating prepared tanks than in the traditional tanks. The microbiological water quality was measured on different water qualities on Zealand, which generally has hard water compared to many places in Jutland. The scattering of the waterworks on Zealand does, however, not indicate significant geographical differences in the number of bacteria, and the results are expected to be national. The study included different manufacturers of solar heating prepared tanks and traditional tanks thus making the results representative of a broad segment of the types of tanks, which typically are marketed at the present time. *Legionella* was not determined in this investigation, but lately the problems concerning Legionnaires' disease have been discussed and the next investigations will include measurements of *Legionella*.

**References**

- Bagh, L.K. (1998). Microbiological water quality in hot-water systems. SBI Report 298.
- Bagh, L. K., Albrechtsen, H.-J., Arvin, E. and Schmidt-Jørgensen, F. (1999). Development of equipment for *in situ* studies of biofilm in hot water systems. *Biofouling* 14(1), 37-47.
- Bagh, L. K., Albrechtsen, H.-J. og Arvin, E. (1995). Growth of bacteria in hot water tanks. *Water Technique*, 63/4:159-163.
- Bagh, L. K., Albrechtsen, H.-J. og Arvin, E. (1993). Bacterial growth potential in hot water systems. *Water Technique*, 61/10:528-534.
- Bagh, L. (1993). Growth of bacteria in hot water systems with electrolytic corrosion protection. SBI-Bulletin 104. The Danish Building Research Institute, Hørsholm.
- Bagh, L.K., Albrechtsen, H.-J. og Arvin, E. Bacteriological growth in hot water tanks. *Water Technique* 63/4:159-163.
- Bechmann, Dorthe. (1996). Strategies for future water supply in residential areas. SBI Report 260.
- Danish Building Regulations. Ministry of Housing and Urban Affairs. (1995). Building Regulations for smaller houses. (20. July 1995).
- Danish Standard Proposal (1996). Investigation of water. Measuring heterotrophic plate counts in hot water. Brandt, T., Christiansen, S. and Lund, C. Ovesen, K., Schmidt-Jørgensen, F. og Bagh, L.K. (1994).
- Bacterial growth in Hot Water Systems. SBI Report 235. The Danish Building Research Institute.
- Ovesen, K., Salomonsen, K. B., Bagh, L. K. og Jørgart, K. (1996). Skin irritations in connection with showering. Investigations and remedies at the workplace. SBI-Report 263. The Danish Building Research Institute.
- Ovesen, K., Salomonsen, K. B., Jørgart, K. Sigbrand, L. P. og Bagh, L. K. (1997). Survey and influencing of the bacterial growth in large domestic hot-water installations. SBI-Report 264. The Danish Building Research Institute.
- Reasoner D. J. and Geldreich E. E. (1985). A New Medium for the Enumeration of Subculture of Bacteria from Potable Water. *Appl Environ. Microbiol.* 49(1), 1-7.

## 9b Bacterial growth in solar heating prepared, traditional and solar tanks

M.Sc. Ph.D. Lene Karen Bagh  
Rovesta Miljø I/S  
Betonvej 12, DK-4000 ROSKILDE, Denmark  
Tel: +45 4677 3794  
Fax: +45 4677 3795  
E-mail: [lkb@rovesta.dk](mailto:lkb@rovesta.dk) Website: [www.rovesta.dk](http://www.rovesta.dk)

M.Sc. Klaus Ellehauge  
Danish Technological Institute  
Teknologiparken, DK-8000 ÅRHUS C, Denmark  
Tel: +45 7220 1370  
Fax: +45 7220 1019  
E-mail: [klaus.ellehauge@teknologisk.dk](mailto:klaus.ellehauge@teknologisk.dk) Website: [www.solenergi.dk/center/](http://www.solenergi.dk/center/)

### General

The objective of this investigation was to study the number of *Legionella* in smaller households in order to conclude whether solar heating prepared tanks or solar tanks gave rise to an increased number of *Legionella* in the water compared to traditional tanks. The difference between growth of *Legionella* in solar heating prepared, solar tanks and traditional tanks were measured by Standard Methods for cultivation of *Legionella*.

The microbiological study was carried out by investigation of water samples from solar heating prepared tanks, solar tanks and traditional tanks from smaller households in May, June and July 2000. For the study 8 solar heating prepared tanks, 8 solar tanks and 8 traditional tanks were selected. From each hot water tank there was taken one water sample. The tanks were geographically scattered on Zealand thus taking samples from different waterworks.

The results are shown in Figure 1 and Figure 2.

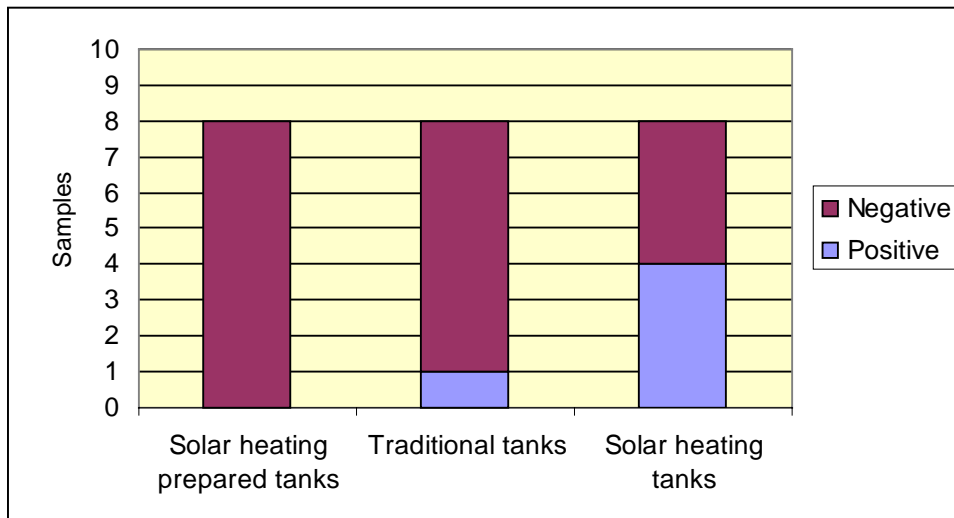

Figure 1. The distribution of positive and negative samples in solar prepared tanks, traditional tanks and solar tanks.

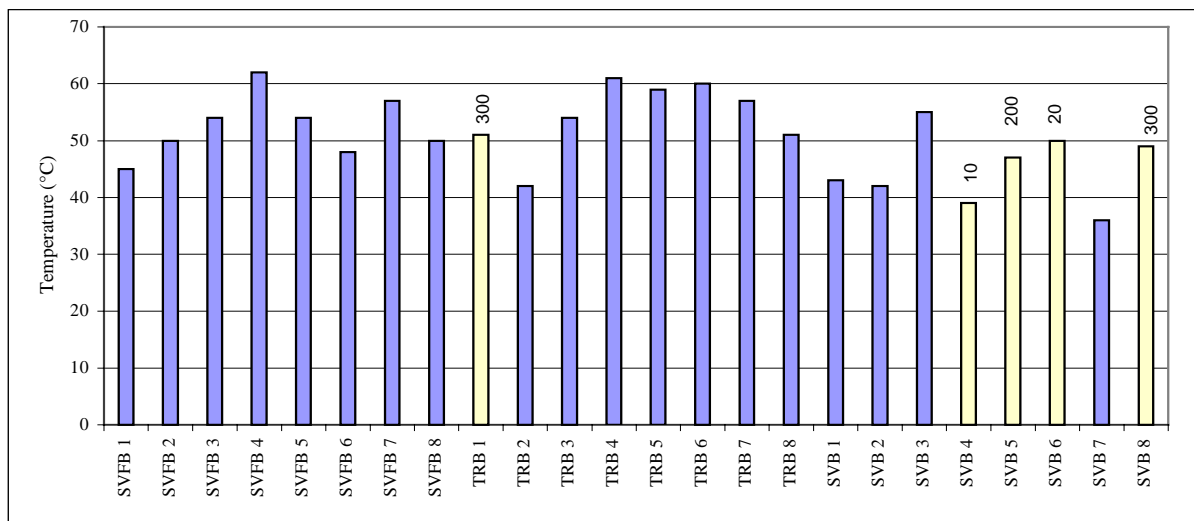

Figure 2. The measured temperature in the hot water samples from the hot water systems with solar prepared tanks (SVFB), traditional tanks (TRB) and solar tanks, respectively. Samples with *Legionella* are shown in yellow with . The concentration of *Legionella* is measured in CFU/l.

The investigation showed that *Legionella* was present in the solar tanks in 50% of the investigated tanks and only in one sample from the traditional tanks *Legionella* was measured. *Legionella* was not measured in the solar heating prepared tanks. However, the concentrations of *Legionella* were low compared to concentrations found in bigger apartment buildings. But it still shows that if the growth conditions for *Legionella* are favoured, they will grow in hot water in smaller buildings as well.

## 10 Concentration of Legionella in hot water electrical storage systems

**Bruno Ziegler**  
**EDF/DER**

**1 Avenue du General De Gaulle, F-92141 CLAMART, France**

**Tel: +33 1 47 65 32 83**

**Fax: +33 1 47 65 52 45**

**E-mail: [bruno.ziegler@edf.fr](mailto:bruno.ziegler@edf.fr) Website: [www.edf.fr](http://www.edf.fr)**

*(powerpoint presentation)*

### **Main goals**

- Identify the evolution of concentration of Legionella in storage vessels.
- Depending on:
  - set temperature;
  - heating control;
  - design of storage.

As the Legionella concentration may be influenced Edf, main electrical utility in France, decided to perform some experiments in the test facilities of its research centre. The test facilities offers the possibility to change the following parameters which are relevant to affect the concentration in Legionella in the hot water installation.

### **Nature of the experiments**

Hot water demand: from 80% to 120% of the total capacity.

Heating scenario (3): temperature of each vessel 50 °C to 70 °C (3 vessels of 1500 litres each).

Design of storage (3):

Measurements:

- [Legionella] 2 times a day in 5 points of the storage system.
- temperature and energy.

Measurements procedure for samples: The outlet pipe for draw off is heated with a small gas burner just before the burner before draw off. The first litre is not taken under consideration. The second litre is collected in a sterilised vessel. Legionella is measured after breeding in Petri box. The measurements have been performed by an independent laboratory - Laboratoire d'Hygiène de la Ville de Paris - which as an agreement for this measurements and which is connected to the French network on Health.



### Hot water production for large system Basic design

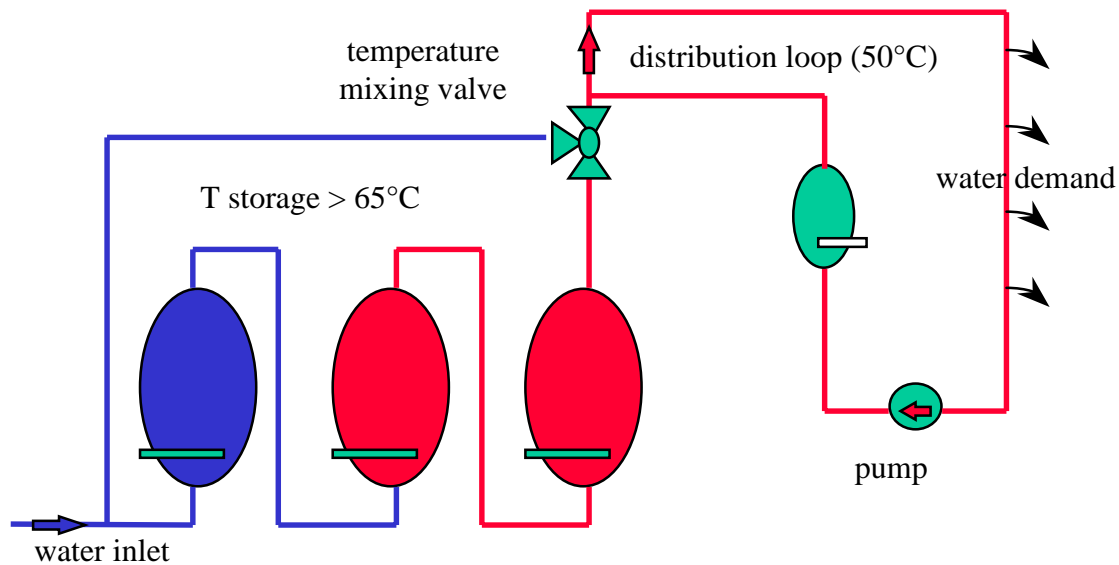

#### Two zones

- Storage: The total volume corresponds to the maximum demand of hot water regarding the nature of the building. The set temperature is assumed to  $65 \pm 5^\circ\text{C}$ .
- Distribution loop: The thermal losses of the distribution loop are compensated with a heater located on the return line.

### Hot water storage system

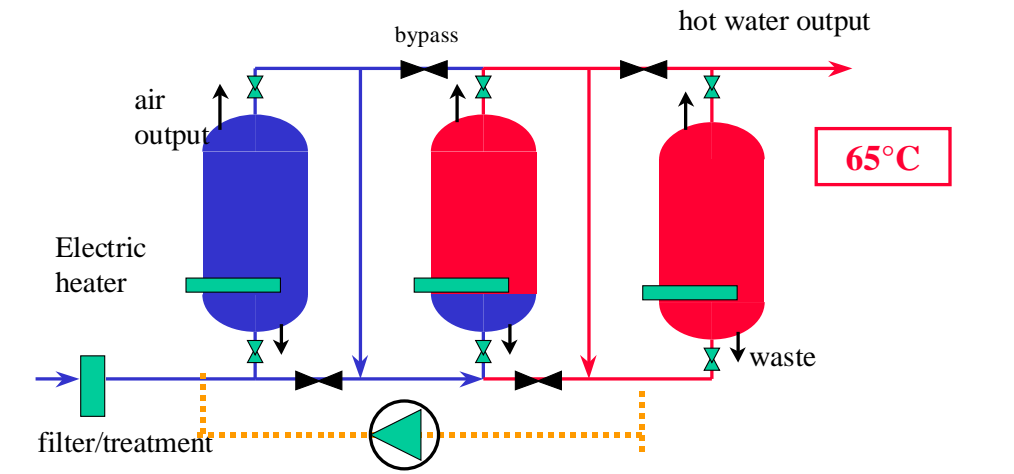

Particular design of the electrical heaters: The electric heater is not located at the bottom of the vessel. In normal conditions the lowest part of the vessel is heated thanks to conduction effect. As the set temperature is  $65^\circ\text{C}$  the temperature in the lower part of the vessel is only  $45^\circ\text{C}$ . The bottom of vessel 2 and 3 are reheated when the hot water from the upper part of the previous vessel is introduced in the bottom of the next vessel.

### Hot water distribution system

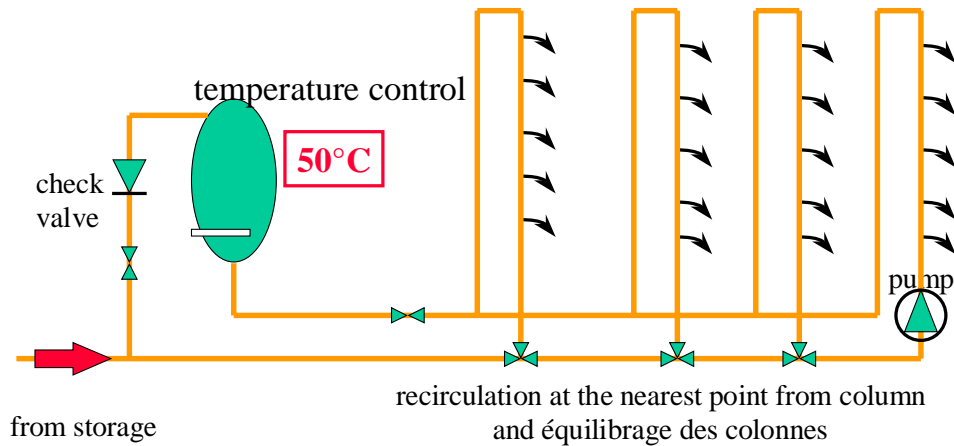

### Hot water demand

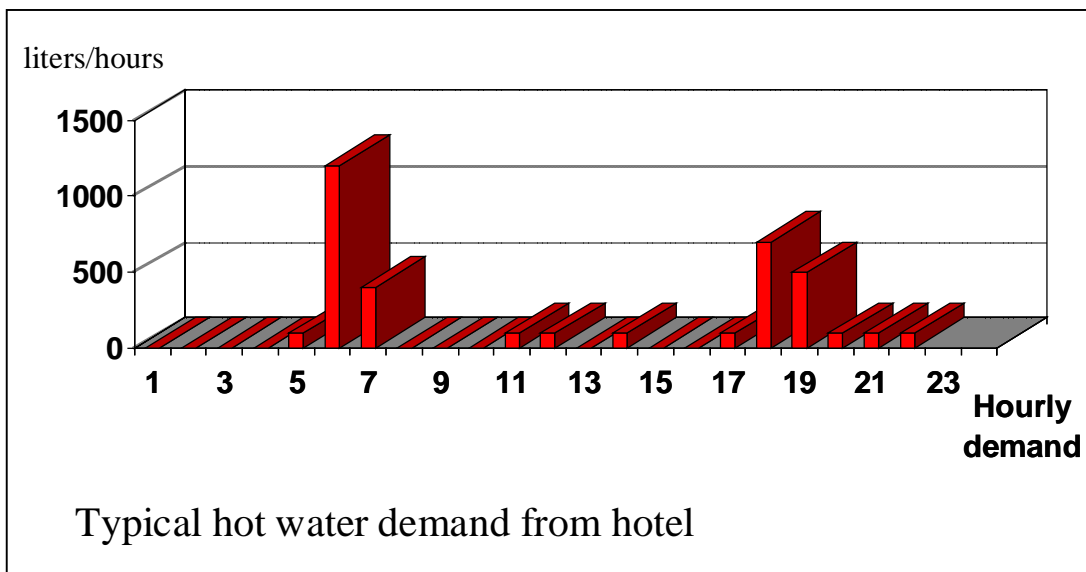

The scenario for hot water demand represents a typical scenario from hotel (or dwellings). The main hot water demand is in the morning and two other period are observed around 12 a.m. and 7 p.m. During the experiment the mass flow rate is constant (800 litre/ h) and the duration of draw off is adapted to the target value depending on a hourly scenario.

### Test procedure

- |         |   |
|---------|---|
| Phase 1 | Introduction of bacteria Legionella (2 litre - [108 ufc/litre])                                       |
| Phase 2 | Breeding (1 week at 35°C)<br>storage volume: 4500 litres<br>target value [Legionella] = 106 cfu/litre |
| Phase 3 | Start of tests (3 scenarii - 6 days)  |
| Phase 4 | Thermal destruction (48hours - 70°C)  |

**Monitoring**

2 Litres of a high concentration solution is introduced at Day - 8 in the vessel. The set temperature is 35 °C during 7 days in order to obtain a concentration of Legionella of 10<sup>7</sup> cfu/litre in the whole installation. At Day the first samples are obtained and the set temperature of the vessels are oved to the designed ones. The samples are obtained daily, twice a day at 9 a.m. and 5 p.m. After 5 days experiment, the set temperature of any vessel is increased to 70 °C during 2 days.

**Scenario 1** Set temperature 65 °C - Heating period [22:00 - 06:00]

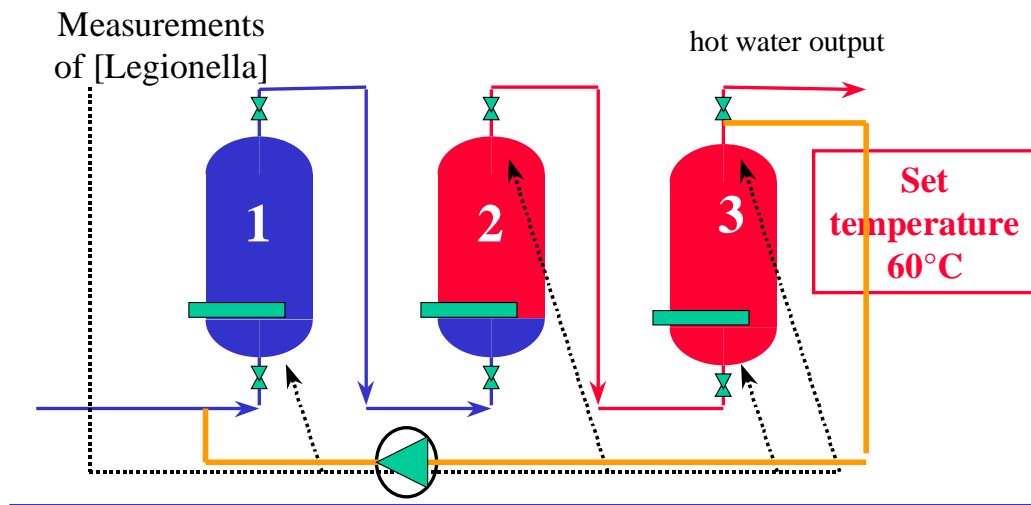

**Evolution of concentration vs time**

Set temperature 65 °C - Heating period [22:00 - 06:00]

Results of the basic case (Set temperature: 65 °C): The concentration of Legionella never exceeds the target value from WHO (103 cfu/litre) at the output of the storage, though higher value may be observed at the bottom of the vessels.

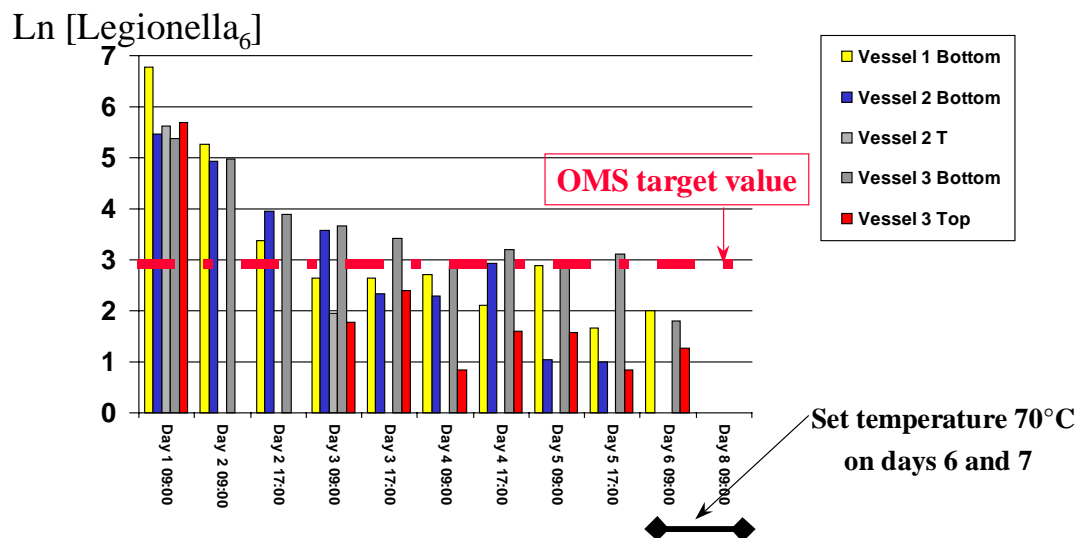

**Scenario 2** A pump is switched on from 04:00 to 06:00, Set temperature 65 °C - Heating period [22:00 - 06:00].

*Storage design n° 2*

In this design a pump operates from 4am to 6 am at the end of the heating period (22 p.m. to 6 a.m.). this pump allows a homogeneity of the temperature in the storage.

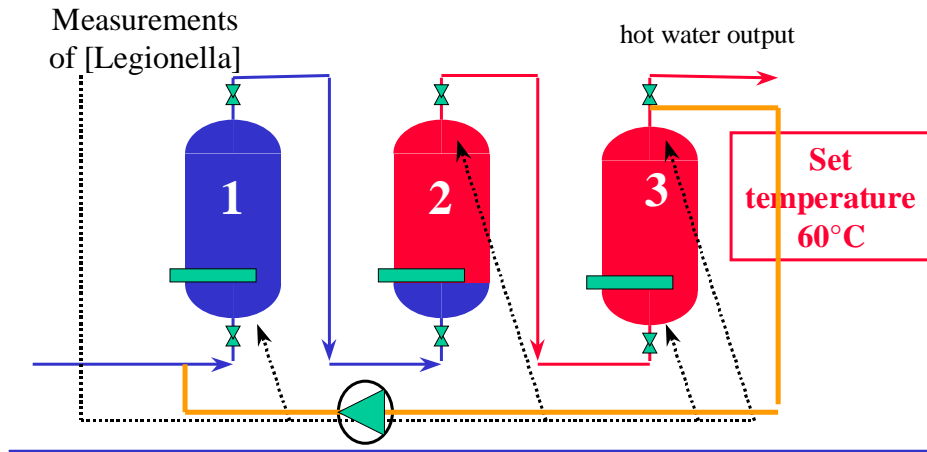

**Evolution of concentration vs time**

Set temperature 65 °C - Heating period [22:00 - 06:00], Operating pump for homogeneous during [04:00 - 06:00]

Results: A quicker reduction of the concentration is observed but the bottom of the vessel is still infected with Legionella.

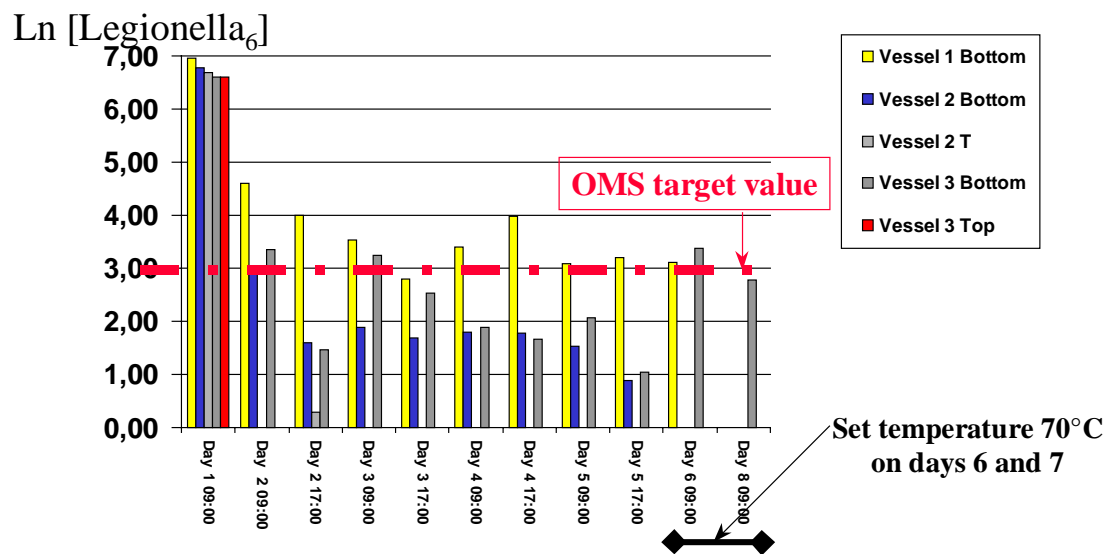

**Scenario 3** Vessel 1 and 2: Set temperature 65 °C - Heating period [22:00 - 06:00],  
 Vessel 3: Set temperature 50 °C - Heating period [00:00 - 24:00]

*Storage design n° 3*

In this design, the final vessel is always maintained at a target value of 50 °C (same value that the distribution loop). A pump operates from 4 am to 6 am at the end of the heating period (22 p.m. to 6 a.m.). this pump allows a homogeneity of the temperature in the storage.

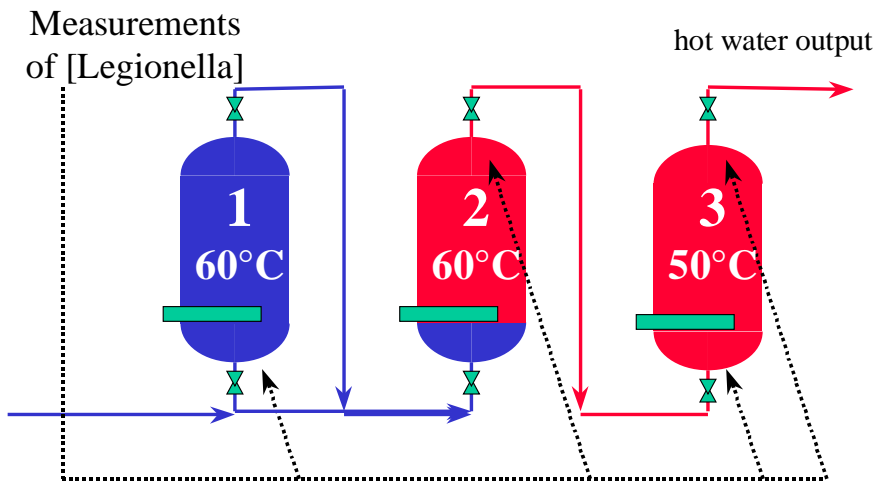

Evolution of concentration vs time Set temperature 65 °C - Heating period [22:00 - 06:00], Operating pump for homogeneous during [04:00 - 06:00].

Result: As observed in design n°1, some Legionella are still observed at the bottom of the vessels though none is measured at the top of the vessels.

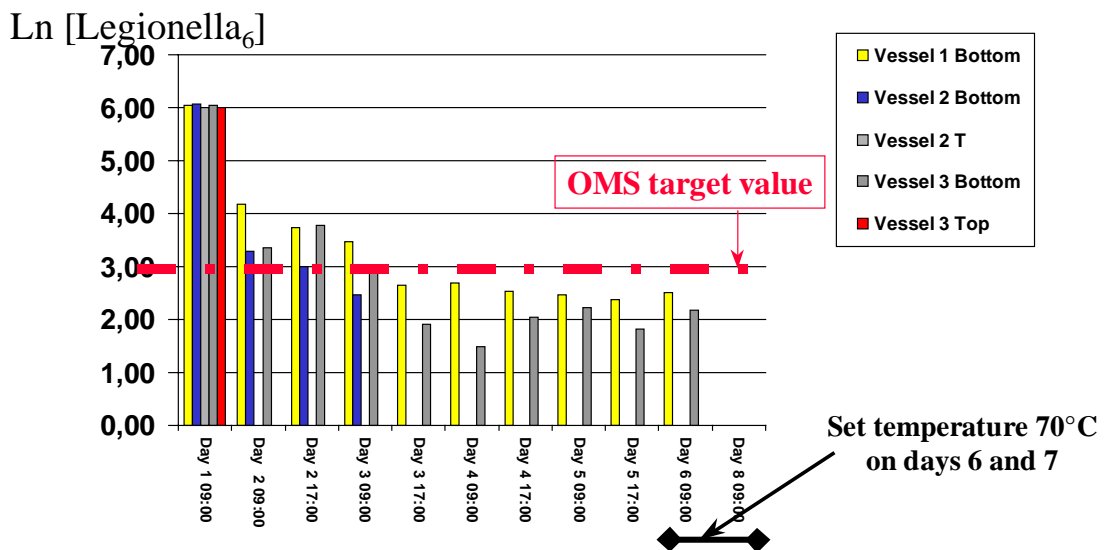

**Evolution of Legionella: Main conclusions**

- [Legionella] reduces 2 log for a heating period of 8 hours at 65°C.
- No Legionella detected at the output of the system after 2 days (in any scenario).
- Temperature of 70 °C is not sufficient to eradicate Legionella in all the system.
  - Legionella still present in piping (where there is no circulation) and may infest the system if temperature decreases.
  - Physical barriers has to be improved to reduce the volume of non circulating water.

## 11 Risk of Legionnaires' disease in Solar Water Heaters - Status report

**Dr. Karl Leidig**  
**Globe Solar GmbH**  
**Diebacher Str. 4**  
**D-91610 INSINGEN, Germany**  
**Tel: +49 (0) 9869 700**  
**Fax: +49 (0) 9869 972 130**  
**E-mail: [solar-leidig@t-online.de](mailto:solar-leidig@t-online.de) Website: [www.solar-leidig.de](http://www.solar-leidig.de)**

### **Preface**

In Germany the systematic research on this topic is consequently neglected since many years. Thermal Legionella Prevention without knowledge about and checks on the actual attack situation, as preferred by DVGW, prevents both the analysis of undisturbed systems as well as the evaluation of the Legionella status in the traditional sanitary technology. Therefore it is largely unknown which threshold values in the water of a shower water supply really lead to an elevated infection risk. Through German and partly EC research, demonstration and market introduction programs a multiplicity of solar thermal installations almost any size has been erected/supported since many years. The potential (numbers of installations) resultant from these activities was neither used by German Ministry of Economics and Technology (BMWi) nor dependant organisations, to systematically investigate traditional as well as solar backed installations on the endangering by increase of Legionella numbers or possible differences between traditional and solar systems, in a number sufficiently high for mortgageable statements.

Different protagonists from the subjects microbiology, hygiene, plumbers, heating and sanitary technology as well as solar technology have gained independently single results concerning the problems to Legionella increase in technical systems (roadly), endangering through Legionella increase, the necessity and effectiveness of means of prevention and/or reconstruction. Parallel to this, different rules and guidelines have been released regarding the whole range from 2 and more family housing, industry and pool shower systems up to water heating and distribution systems in hospitals. Up to now, these results have not been put together and centrally appraised. In result of this, in Germany the not clearly defined risk on Legionella increase in hot water systems is been treated very differently and in the general discussion there is hardly any differentiation between hot water systems, humidifiers and air conditionings. Moreover, statistically sufficiently secured examinations are missing to the effectiveness and to the energy consumption of alternatives, for example UV-Irradianca in comparison to the thermal prevention/disinfection.

## 1. Facts

1. Legionella increase in drinking water installations and their components is no solar specific problem, even though it must not be misjudged, that solar installations frequently run at temperatures, that favour the increase of Legionella. This is applied however also to a multiplicity of other hot water systems like also for installations, in which is used waste heat for prewarming of drinking water in the sense an efficient energy application for example.
2. Generally the use of big warm storage volumes promotes the increased appearance of Legionella and other germination.
3. Legionella increase in hot water systems is a multifactorial occurrence, on which water composition, use of certain installation materials, biology of the specific Legionella type, temperature, system formation, duration of the water storage have an influence among others. The practical relevance of the individual factors respectively their combinations is not yet scientifically proved.
4. Diseases caused by Legionella aspiration appear in Germany non-epidemic but rather sporadically.
5. Concerning utilisation of hot water systems also internationally only few epidemic outbreaks are documented. Bigger infection numbers have appeared with utilisation of for example air conditionings and humidifiers.
6. The general thermal Prevention
  - offers no sure protection but decreases the possibly existing risk of an uncontrolled Legionella increase.
  - causes a high energy consumption without offering defined protection.
  - gains only rule security without hygienic security of the technical system.
7. Different rules to the allowed as well as assigned temperature in the hot water system (hospital ordinances: allow at most 50°C; DVGW: assigned at least 60°C) lead to considerable uncertainty and too technically sophisticated and therefore mistake susceptible system designs - or to the not-observation one of the rules.

## 2. Technical rules

DVGW Worksheets W551 and W552;

- Valid for > 3 households per system  
or > 400 l storage volume (without any consideration of the storage time)!
- or > 3 l pipe volume in the longest connecting pipe;
- recommendations of the association for its members;
- mark the state of technology;
- put thermal prevention in favour;
- suggest the optimised system design;
- demand regular measurements, if no thermal prevention is driven;
- put up harder limits for areas with low risk, for example collective shower installations in industrial plants (directly reconstruction for more than 10 active Legionellas per ccm, restricts utilisation and soon reconstruction for more than 100 active Legionellas per ccm), as for example the health ministry in the county of Brandenburg for areas with moderate risk in hospitals (100 active Legionellas per ccm).



### 3. Epidemiology

- Different sources assume for Germany, with annually approximately 8.000, 9.000 illnesses (calculated for unified Germany on data of Western Germany) approximately 1.300 deaths p.a. From these infections up to 25% are assumed to be acquired in hospitals.
- With this, from the medical point of view, the infection is classified to be rather rarely concerning to the natural occurrence of Legionella.

### 4. Conventional installation technology

- In low energy houses more and more large drinking water storages are to be used since a single pass water heater would need more thermal power than the on space heating layouted heating system could provide.
- The DIN/DVGW Certificate for all components of a hot water system possibly offers a certain protection before materials, that favour the increase of Legionella. Epidemiological studies to this topic are missing.
- More constructively Legionella prevention by non Legionella and biofilm friendly system design (short piping, smaller storages, avoidance of unused string piping).

### 5. Solar thermal systems

- DIN/DVGW Certificate of the components (standard of the plumbers, heating and sanitary technology).
- Avoidance of big drinking water storages, construction of heating storages, solar buffer storage without drinking water filling, with drinking water exchanger (internal/external).
- Bivalent (double powered) drinking water storages with storage volumes of less than 400 litres for example in the one family house area.
- Modern solar storage for space heating support are designed as so called combi storages with drinking water heat exchanger (internal/external) for single pass hot water supply and with cold water inlet in the upper (thoroughly heated) storage area.
- More favourable technical parameters of modern sun collectors and with it higher working temperatures promote the solar space heating support also at modern low energy houses.
- Larger solar collector aperture of systems for solar heating support generate temperatures of above 60°C, what compares to thermal prevention, in the upper storage region several times during the summer time. In the winter months, these storage temperatures are reached easily by the auxiliary.

A potential risk occurs in solar hot water systems with large drinking water storage that are over dimensioned and/or, concerning the state of the art in systems design, wrongly designed (cold water inlet not in the surely heated area). Over dimensioning may also occur to elder systems when actual load is much smaller than originally designed for.

In all these cases thermal prevention results in a hygienic and/or energetic problem.

## 6. Reputation of solar hot water systems

Earlier the Legionella problem was regarded as a typically solar problem since:

- solar installations prefer low storage temperatures;
- planners and user of solar hot water systems are more sensitised on environmental problems and possible health risks.

The problem has largely returned to normal today.

Specific communication measures, that risks from Legionella increase are no specific solar problem are assumed to be rather counter productively because solar thermal is standard as well as traditional hot water and heating systems.

## 7. What has to be done

Systematic summary of all in Germany present realisations.

- Utilisation of the existing potentials to the improved evaluation of the problem regarding.
- occurrences of critical numbers of Legionella in technical systems.
- Influential factors on the increase of Legionella in technical systems.
- Effect of infection mechanisms after Aspiration of Legionella.
- Economic viability and hygienic effect of Legionella prevention, also from alternatives to the thermal prevention.

## To the point

Necessary is a multi centric data recording over the whole country covering on among others:

- Type of hot water system (as well solar and non-solar),
- Size and topology of the hot water production and distribution system,
- Applied means of Legionella prevention,
- Number and specific type of Legionella in the warm/cold drinking water,
- Legionella caused illnesses at the system.

## Authors

Dr.Ing. Christian Fünfgeld  
DGS Fachausschuß Thermie

Liv Fünfgeld  
Ärztin

Dr. Karl Leidig  
Globe Solar GmbH

Dr.Ing. Felix A. Peuser  
ZfS – Rationelle Energietechnik GmbH

## 12 In situ survey of Legionella in Belgium

**Ir. K. de Cuyper**  
**BBRI**  
**Avenue P. Holoffe 21**  
**B-1342 LINELETTE, Belgium**  
**Tel: +32 2 655 77 11**  
**Fax: + 32 2 653 07 29**  
**E-mail: [karel.de.cuyper@bbri.be](mailto:karel.de.cuyper@bbri.be) Website: [www.bbri.be](http://www.bbri.be)**

*(powerpoint presentation)*

### Content

1. Introduction
2. 1991-1993 Survey
3. Actual research at BBRI

### 1. Introduction

Due to a Legionella problem in “new” (= <10 years old) hospital in 1988, BBRI was asked by the plumber what to do from the side of the installation -> literature was analysed.

### 2. 1991-1993 BBRI survey on sanitary hot water installations

| Building          | Number | With L pn |
|-------------------|--------|-----------|
| Single family     | 30     | 0         |
| Appartment        | 16     | 4         |
| Hospital          | 8      | 5         |
| Sportcomplex      | 6      | 1         |
| Office            | 2      | 2         |
| Homes for elderly | 1      | 0         |
| TOTAL             | 63     | 12        |

- No L pn. in single family houses or apartments with individual heating;
- Collective buildings with centralised hot water production: 40% are contaminated;
- Parameters of positive influence:
  - Temperature: the lower T, the higher L pn;
  - Presence of Fe in the water: corrosion;
  - Bigness of the installation.
- Recommendations were established in 1997 for the conception of new installations for hot water production and supply.

### 3. Actual BBRI research

Period: 2000-2002

Aim:

- Evaluation – in situ - of anti Legionella treatments for sanitary hot water:
  - Physical: UV, temperature
  - Chemical:
    - Electrolysis;
    - ClO<sub>2</sub>;
    - Cu/Ag.
- Efficacy evaluation
  - Global
  - Effect of
    - Presence of deposits: sludge, corrosion products
    - Biofilms
- Effect on durability:
  - Corrosion
  - Thermal effects, ...

Preliminary results:

- Difficulty of realising a thermal disinfection;
- Chemical treatment:
  - only “immediately” effective after a “good” thermal disinfection;
  - otherwise: a long waiting time = function of importance (length)of system and of biofilm: months!!!
  - dangerous in case of failure;
  - really effective: Cu/Ag.
- UV: only effective in disinfected installations.

Corrosion:

- Incompatibility:
  - Cu/Ag treatment and galvanised pipes
- No corrosion problem with ClO<sub>2</sub> and galva pipes in case of anti-corrosion treatment

## 13 Legionella research topics

Hans van Wolferen  
 TNO MEP  
 P.O.Box 342  
 NL- 7300 AH APELDOORN, The Netherlands  
 Tel: +31 55 549 37 67  
 Fax: +31 55 549 37 40  
 E-mail: [Hans.vanWolferen@mep.tno.nl](mailto:Hans.vanWolferen@mep.tno.nl) Website: [www.mep.tno.nl](http://www.mep.tno.nl)

(powerpoint presentation)

### Contents

- Ecology of Legionella;
- Detection and identification;
- Fresh water and water treatment;
- Transport and distribution;
- Water installations in buildings;
- Other installations;
- Infection.

### Ecology of Legionella

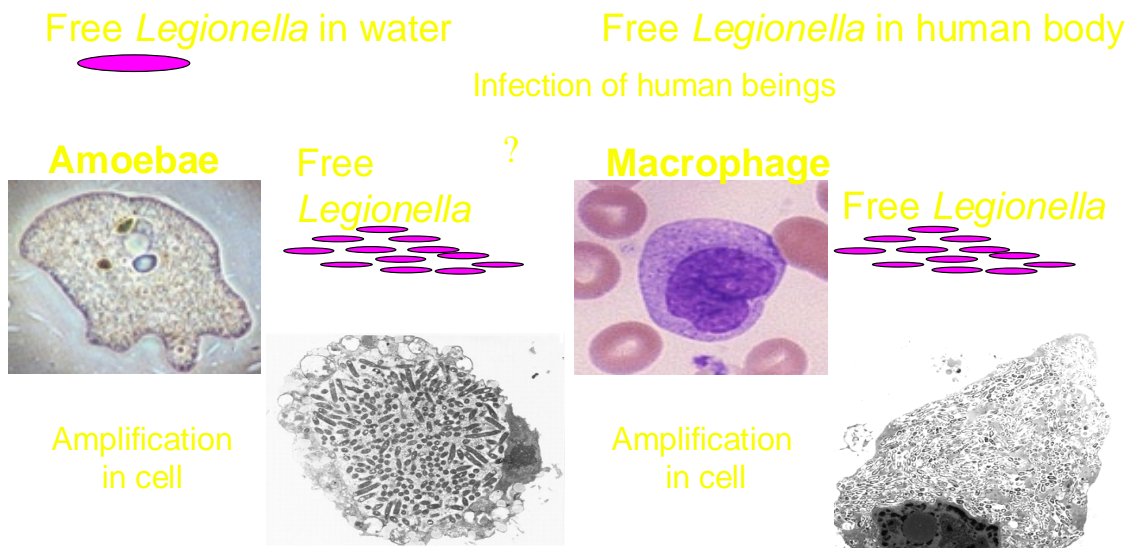

- Protozoa & Amoebae types hosting L;
- Amplification factors (temperature, water composition, tube material, stagnation).

**Detection and identification**

- Performance assessment & criteria for detection methods;
- Improvement / standardisation of different methods (culture, PCR, FISH, DFA);
- Identification of species, serotype, genotype.

**Fresh water and water treatment**

- L. concentration in fresh water;
- L. elimination in water treatment;
- L. growth in water treatment.

**Transport and distribution**

- Risk analysis & monitoring of distribution systems;
- Side effects of chemical addition for disinfection (monochlorine-amine).

**Water installations in buildings**

- Risk factors in dwellings;
- Risk of special appliances;
- Evaluation of thermal treatment
- Performance assessment of alternative treatments;
- Performance assessment of disinfection methods;
- Database of accidents / detection results.

**Other installations**

- Cooling towers;
- Humidifiers;
- Swimming pools;
- ...

**Infection**

- Aerosol generation;
- Legionella in aerosols;
- Aerosol spread and diminishing;
- Aerosol inhalation;
- Toxic dose of L.

## 14. Microbiological safety of Solar Domestic Hot Water Systems

Daniel .J. Naron  
TNO Bouw  
PO. Box 49  
NL-2600 AA Delft, The Netherlands  
Tel: +31 15 269 52 49  
Fax: +31 15 269 52 99  
Email: [D.Naron@bouw.tno.nl](mailto:D.Naron@bouw.tno.nl) Website: [www.bouw.tno.nl](http://www.bouw.tno.nl)

*(powerpoint presentation)*

### **Exploratory study Legionella & SDHW Systems (2000)**

- Method development
  - Predict occurring temperatures in SDHW Systems
    - Theoretical basis
    - Based upon geometrics Solar Store
- With this 'tool':
  - Summer: no Legionella risk (too hot in store)
  - Winter: possible Legionella risk
- **IMPORTANT: ONLY TEMPERATURES CONSIDERED!**
- For presence of Legionella also:
  - Bacteria
  - Biofilm (nutrient medium)
  - Sediment
  - Stagnation (stagnant water)
  - 'Nutrients' in water ( = bad water composition)

### **Question**

Is there a risk at all for Legionella in SDHW Systems?

Or:

Does a Set of Requirements exist for SDHW Systems for which the Legionella risk is neutraal? => Research !!

### **Goal**

To Define a Set of Requirements for SDHW Systems with a Legionella-neutraal risk:

- Certificate
- No supplementary requirements necessary for after heaters

### **Approach**

5 fases

- Inventory study
- Theoretical study (simulations / literature)
- Experimental fase

- Define Set of Requirements
- Verification Set of Requirements

### **1. Inventory**

Of the present SDHW systems in NL:

- Principle (how does it work)
- Materials
- Constructions
- Operation (different states)
- Where is a theoretical Legionella risk

Which SDHW systems will be taken in this study?

### **2. Theoretical study**

- Temperures
  - How often and how long 'risk temperatures'
  - TNO-model
- Biofilm
  - How strong does the biofilm grow (as a nutrient for Legionella) on materials used in SDHW systems
  - Literature study
- Construction SDHW System
  - So Called 'Hygienic Design'  
Popular: How wel a SDHW system cleans itself
  - Standards (experts TNO Nutrition and Food Research)

### **3. Experiments**

- 'Hygienic Design' of a SDHW system in practice
  - Select 10 SDHW systems (now operating in the market - with SDHW industry)
  - In laboratory dismantled and examined (biofilm, sediment, materials (corrosion?) en others)
- Biofilm formation
  - On materials of which there are no data present
  - Examined under normal operating conditions SDHW systems
- High Temperatures
- What is the effect of thermal disinfection on the materials (and the biofilm) in the SDHW System?

### **4. Definition of Set of Requirements**

Sufficient info for:

- Definition of Set of Requirements
- In case a SDHW system comply with the Set of Requirements:
  - Certificate: Legionella-neutrale status
  - Quality Certificate (Dutch Energy Performance Label)

### **5. Experimental verification**

2 SDHW systems that just complies the Set of Requirements:



- Mount in Lab
- Infect with Legionella
- Operate under normal SDHW conditions
- Frequent sampling

Experimental determination whether it is feasible to use the defined Set of Requirements to give this Certificate Legionella Neutral SDHW System

**Division of Tasks**

- TNO Building and Construction Research / TNO Nutrition and Food Research
- Kiwa
- SDHW Industry